

2013 Chevrolet Corvette Navigation System

Infotainment System	3	Problems with Route Guidance	72
Introduction	3	If the System Needs Service	73
Overview	4	Ordering Map DVDs	73
Radio	12	Database Coverage Explanations	73
AM-FM Radio	12	Voice Recognition	73
Satellite Radio	20	Trademarks and License Agreements	80
Audio Players	21	Index	i-1
CD Player	21		
Auxiliary Devices	30		
Navigation	30		
Using the Navigation System	30		
Enter Destination	32		
Stored Locations	45		
Navigation Set Up	54		
Route Options	58		
Maps	63		
Navigation Symbols	66		
Navigation Menu	70		
Global Positioning System (GPS)	71		
Vehicle Positioning	71		

Introduction



The names, logos, emblems, slogans, vehicle model names, and vehicle body designs appearing in this manual including, but not limited to GM, the GM logo, CHEVROLET, the CHEVROLET Emblem, CORVETTE, the CORVETTE Emblem, CORVETTE GRAND SPORT, Z06, and ZR1 are registered trademarks and/or service marks of General Motors LLC, its subsidiaries, affiliates, or licensors.



Manufactured under license under U.S. Patent #'s: 5,451,942; 5,956,674; 5,974,380; 5,978,762; 6,487,535 and other U.S. and worldwide patents issued and pending. DTS and the Symbol are registered trademarks and DTS Digital Surround and the DTS logos are trademarks of DTS Inc. All Rights Reserved.



Manufactured under license from Dolby Laboratories. Dolby and the double-D symbol are trademarks of Dolby Laboratories.



“Made for iPod” means that an electronic accessory has been designed to connect specifically to iPod and has been certified by the developer to meet Apple performance standards.

iPod is a trademark of Apple Computer, Inc., registered in the U.S. and other countries.

The information in this manual supplements the owner manual.

This manual describes features that may or may not be on your specific vehicle either because they are

4 Infotainment System

options that you did not purchase or due to changes subsequent to the printing of this owner manual. Please refer to the purchase documentation relating to your specific vehicle to confirm each of the features found on your vehicle. For vehicles first sold in Canada, substitute the name “General Motors of Canada Limited” for Chevrolet Motor Division wherever it appears in this manual.

Keep this manual with the owner manual in the vehicle for quick reference.

Canadian Vehicle Owners

Propriétaires Canadiens

A French language copy of this manual can be obtained from your dealer or from:

On peut obtenir un exemplaire de ce guide en français auprès du concessionnaire ou à l'adresse suivante:

Helm, Incorporated
P.O. Box 07130
Detroit, MI 48207

1-800-551-4123
Numéro de poste 6438 de langue française
www.helminc.com

Overview

Read this manual thoroughly to become familiar with how the navigation system operates.

The navigation system includes navigation and audio functions.

Keeping your eyes on the road and your mind on the drive is important for safe driving. The navigation system has built-in features intended to help with this by disabling some features when driving. A grayed-out function is not available when the vehicle is moving.

All functions are available when the vehicle is parked. Do the following before driving:

- Become familiar with the navigation system operation, buttons on the faceplate, and touch-sensitive screen buttons.
- Set up the audio by presetting favorite stations, setting the tone, and adjusting the speakers.
- Set up the navigation features, such as entering an address or a preset destination.
- Set up phone numbers in advance so they can be called easily by pressing a single

button or a single voice command for navigation systems equipped with phone capability.

 **WARNING**

Taking your eyes off the road too long or too often while using the navigation system could cause a crash and you or others could be injured or killed. Focus your attention on driving and limit glances at the moving map on the navigation screen. Use voice guidance whenever possible.

Use the navigation system to:

- Plan a route.
- Select a destination using various methods and choices.
- Follow turn-by-turn route and map guidance with voice prompts, only if permitted by traffic laws, controls, and conditions.

- Receive RDS broadcast announcements.

Always be alert and obey traffic and roadway laws and instructions, regardless of the guidance from the navigation system. Because the navigation system uses street map information that does not include all traffic restrictions or the latest road changes, it may suggest using a road that is now closed for construction or a turn that is prohibited by signs at the intersection. Always evaluate whether following the system's directions is safe and legal for the current conditions.

When the navigation system is turned on, a screen may appear with information that must be read and acknowledged before accessing some navigation features.

After acknowledging the start up information, the NAV (Navigation) and DEST (Destination) functions are accessible. Information can now







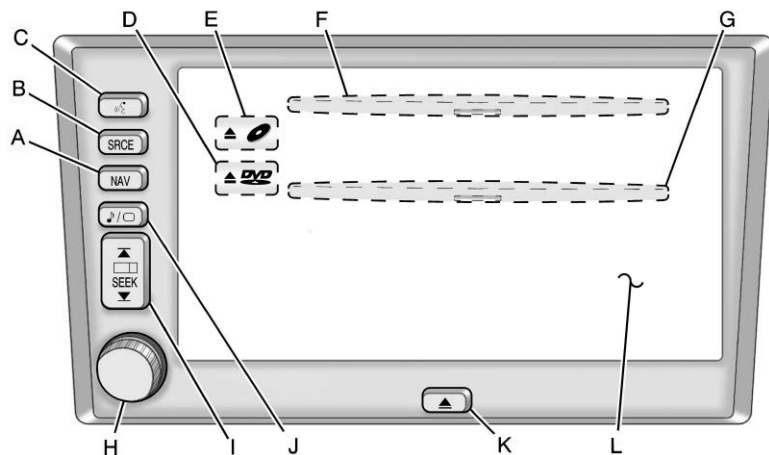

be entered or deleted, and other functions accessed. See instructions later in this section.

Every 50 times the vehicle is started and the navigation system is turned on, the Caution screen appears. After reading the caution, select Agree to load the map DVD information. If Agree is not selected, all control buttons except for NAV (Navigation) and DEST (Destination) can be accessed.

When getting started, set your preferences or delete information in the navigation system using various options.

6 Infotainment System



- A. NAV (Navigation) Key
- B. SRCE (Source) Key
- C.  (Voice Recognition)
- D.  DVD (DVD Map Database Eject)
- E.  (CD Eject)
- F. CD Slot
- G. DVD Map Database Slot
- H. Power/Volume Knob
- I.  SEEK  (Seek/Tune)
- J.  /  (Audio/Adjust) Key
- K.  (Open/Close Faceplate)
- L. Navigation System Screen

Language

To change the language of the prompts that appear on the navigation screens, see “Driver Information Center (DIC)” in the owner manual.

Deleting Personal Information



This navigation system can record and store destinations. You may want to delete stored destinations when the vehicle is sold or the lease has expired. Refer to the following sections to delete the destination information that has been stored.

See “Memory Points,” “Home,” “Previous Destination,” and “Preset Destination” under *Stored Locations* on page 45 for deleting stored destinations.

Storing Radio Station Presets

To set preset radio stations:

1. Press the power/volume knob to turn the system on.

2. Press SRCE and select the desired band (AM, FM1, FM2, XM1, or XM2 (if equipped)).
3. Use   SEEK  to tune to the desired station.
4. Press and hold one of the six preset screen buttons, at the bottom of the screen, until a beep is heard or the station is displayed on the selected preset button.
5. Repeat the steps for each preset.

See "Preset Station Menu" under *AM-FM Radio on page 12*.

Setting the Clock

To set the time:

1. Press the power/volume knob to turn the system on.
2. Press and hold the time display in the upper right corner of any screen.

3. Select the 12H or 24H screen button to display the time in standard or military time.
4. Press and hold the Hour and Min. (minute) arrow buttons to increase or to decrease the time.
5. Select the correct time zone screen button.
6. Select the Daylight Saving Time screen button, if necessary.

The radio uses the GPS satellite to set the time. The vehicle needs to be in an open area to receive the signal. See "Clock" under *AM-FM Radio on page 12*.

Setting the Region, Entering an Address and Point of Interest, and Storing a Home Destination and Preset Destinations

Before entering an Address, Point of Interest, Home, or Preset Destination, select the correct

region that contains the final destination. The vehicle must be stopped to do this operation.

Setting the Region

To set the region:





1. If the radio is already on with a map disc inserted, skip to Step 5.
2. Press the power/volume knob to turn the system on.
3. Insert the DVD map disc. See "Installing the DVD Map Disc" under *Maps on page 63*.
4. A Caution may appear. Press Agree to proceed.
5. Press NAV.
6. Press MENU, located on the screen.
7. Press  (Enter Destination).
8. Press the Region screen button.
9. Select the correct numbered region that contains your final destination.

8 Infotainment System

The system returns to the Enter Destination menu. See *Enter Destination on page 32*.

Entering an Address

To set a destination by entering a street address:

1. If the radio is already on with a map disc inserted, skip to Step 5.
2. Press the power/volume knob to turn the system on.
3. Insert the DVD map disc. See "Installing the DVD Map Disc" under *Maps on page 63*.
4. A Caution may appear. Press Agree to proceed.
5. Press NAV.
6. Press MENU, located on the screen.
7. Press . Verify that the selected Region is correct.
8. Press  (Address).
9. Enter the street name using the alpha keypad on the screen.
Do not enter street direction (i.e. N, S.E., or W) information or type of street (i.e. road, lane, or court) to the address. Use the space symbol screen button () between street or city names. Use the backspace () screen button if an incorrect character has been entered.
10. Select the type of street (Dr., Ln., St., etc.) if it applies, from the list.
11. If there is more than one city, the system displays the list of cities that have a street with that name. Select a city from the list or select the Input Name screen button to enter the city name.
12. Enter the house number using the numeric keypad on the screen and press OK.
A map screen appears with the destination marked.
13. Select  (Destination).
14. Select the Guide screen button.
15. Once driving begins, an audio prompt "Proceed to the highlighted route" is heard. The vehicle is now in route guidance mode.

See "Address" under *Enter Destination on page 32*.

Entering a Point of Interest (POI)

To set a destination by entering a Point of Interest (POI):

1. If the radio is already on with a map disc inserted, skip to Step 5.
2. Press the power/volume knob to turn the system on.
3. Insert the DVD map disc. See "Installing the DVD Map Disc" under *Maps on page 63*.
4. A Caution may appear. Press Agree to proceed.
5. Press NAV.

6. Press the MENU screen button.
7. Press . Verify that the selected Region is correct.
8. Press (Point of Interest).
9. Enter the specific title of the POI in the Name space using the alpha keypad on the screen.
10. Select the POI from the list.
11. If there is more than one city, the system displays the list of cities that have a street with that name. Select a city from the list or select the Input Name screen button to input the city name.
A map screen appears with the destination marked.
12. Select (Destination).
13. Select the Guide screen button.

14. Once driving begins an audio prompt "Proceed to the highlighted route" is heard. The vehicle is now in route guidance mode.

Using the Category or City selections to help find the POI by limiting the search options. See "Point of Interest (POI)" under *Enter Destination on page 32*.

Storing a Home Destination



1. If the radio is already on with a map disc inserted, skip to Step 5.
2. Press the power/volume knob to turn the system on.
3. Insert the DVD map disc. See "Installing the DVD Map Disc" under *Maps on page 63*.
4. A Caution may appear. Press Agree to proceed.
5. Press NAV.
6. Press the MENU screen button.
7. Press (Stored Locations).

8. Press (Home).
9. Press the Add screen button.
10. Press Address and enter all address information.
11. Press OK.
A map screen appears with the destination marked.
12. Press OK.
13. Press the back arrow screen button.
The is highlighted on the Enter Destination screen. See "Using Your Home or Preset Destinations" later in this section.

Storing a Preset Destination

1. If the radio is already on with a map disc inserted, skip to Step 5.
2. Press the power/volume knob to turn the system on.

10 Infotainment System



3. Insert the DVD map disc. See “Installing the DVD Map Disc” under *Maps on page 63*.
4. A Caution may appear. Press Agree to proceed.
5. Press NAV.
6. Press the MENU screen button.
7. Press .
8. Press  (Previous Dest.).
9. Press the Add screen button, then select the numbered preset button for the destination to appear as.
10. Press Address and enter all address information.
11. Press OK.
A map screen appears with the destination marked.
12. Press OK.
13. Press the back arrow screen button.

The numbered preset destination is highlighted on the Enter Destination screen. See “Using Your Home or Preset Destinations” next in this section.

Using Your Home or Preset Destinations

These destinations are available for selection while driving.

1. If the radio is already on with a map disc inserted, skip to Step 5.
2. Press the power/volume knob to turn the system on.
3. Insert the DVD map disc. See “Installing the DVD Map Disc” under *Maps on page 63*.
4. A Caution may appear. Press Agree to proceed.
5. Press NAV.
6. Press the MENU screen button.
7. Press .

8. Select  or one of the available preset destination symbols. A map screen appears with the destination marked.
9. Select .
10. Select the Guide screen button.
11. Once driving begins an audio prompt “Proceed to the highlighted route” is heard. The vehicle is now in route guidance mode.

Canceling Guidance

Guidance is canceled once you arrive at the final destination. To cancel guidance prior to arrival at the final destination:



1. Press NAV to access the map screen.
2. Press the MENU screen button on the map screen.
3. Press  (Route Options).
4. Press Cancel Guidance.

5. Press Yes to confirm cancellation.

Stored Locations



Once a destination has been stored, the address information can then be edited and deleted. See *Stored Locations on page 45* for more information on other features that can be stored, edited, and deleted.

To delete the stored home destination:

1. Press the power/volume knob to turn the system on.
2. Insert the DVD map disc. See "Installing the DVD Map Disc" under *Maps on page 63*.
3. A Caution may appear. Press Agree to proceed.
If the radio is already on with a map disc inserted, press NAV.
4. Press the MENU screen button.
5. Press .
6. Press .

7. Press Delete.
8. A confirmation pop-up screen appears: select Yes to delete; select No to cancel the operation.



To delete a waypoint or a stored preset destination:

1. Press the power/volume knob to turn the system on.
2. Insert the DVD map disc. See "Installing the DVD Map Disc" under *Maps on page 63*.
3. A Caution may appear. Press Agree to proceed.
If the radio is already on with a map disc inserted, press NAV.
4. Press the MENU screen button.
5. Press .
6. Press  (Dest. & Way Pt.) or  (Previous Dest.).
7. Press Delete, then select the way point or the numbered preset button to delete.

8. A confirmation pop-up screen appears: select Yes to delete; select No to cancel the operation.

Guidance Volume

To adjust the volume of voice guidance prompts:

1. Press NAV to access the map screen.
2. Press the MENU screen button on the map screen.
3. Press  (Navigation Set Up).
4. Press  (Guidance Volume).
5. Select the desired volume or select Off. The system plays back the new volume level.

See "Guidance Volume" under *Navigation Set Up on page 54*.

Cleaning the Display

If the panel or the display is stained, wipe it with a dry, soft cloth.

Notice: Using abrasive cleaners when cleaning glass surfaces could scratch the glass. Use only a soft cloth and do not spray cleaner directly on the system as it could affect the mechanical parts.

Do not apply spray cleaner directly to the system, the cleaner could affect the mechanical parts.

Do not wipe the panel with a hard cloth or use a liquid that could ignite, such as thinner or alcohol, it could scratch the surface or erase the characters.

Radio

AM-FM Radio

Notice: Before adding any sound equipment to the vehicle, such as an audio system, CD player, CB radio, mobile telephone, or two-way radio, make sure that it can be added by checking with your dealer. Also, check federal rules covering mobile radio and telephone units. If sound equipment can be added, it is very important to do it properly. Added sound equipment can interfere with the operation of the vehicle's engine, radio, or other systems, and even damage them. The vehicle's systems can interfere with the operation of sound equipment that has been added.

Notice: The chime signals related to safety belts, parking brake, and other functions of the vehicle operate through the navigation system. If that equipment is

replaced or additional equipment is added to the vehicle, the chimes may not work. Make sure that replacement or additional equipment is compatible with the vehicle before installing it. See “Accessories and Modifications” in the vehicle's owner manual.

Your vehicle has a feature called Retained Accessory Power (RAP). RAP lets the audio system play after the ignition is turned off. See “Retained Accessory Power (RAP)” in the owner manual.

The audio system operates using the navigation system menus.

Playing the Radio

Power/Volume Knob: Press to turn the audio system on and off. Turn to increase or decrease the volume to the audio system.



▲ SEEK ▼ :

- Press and hold the up or down arrow until a beep is heard to go to the next or previous station and stay there.

- Press and hold either arrow to perform a fast seek.

SRCE (Source): Press to display the main audio screen.

Audio Adjust Screen

 /  **(Audio/Adjust Screen):**
Press to view the audio and screen settings.

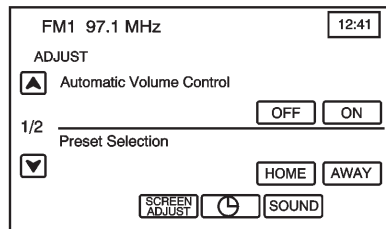

Automatic Volume Control

(AVC): The audio system adjusts automatically with AVC to make up

for road and wind noise while driving. The volume increases as vehicle speed increases.

To use AVC, set the volume to the desired level and then press ON. To turn AVC off, select OFF.

If your vehicle is equipped with a Bose® sound system, it includes Bose AudioPilot® noise compensation technology. When turned ON, AudioPilot continuously adjusts the audio system equalization to compensate for background noise, so that your music always sounds the same at the set volume level.

This feature works best at lower volume settings where background noise may mask the audio. At higher volume settings, where the audio is much louder than the noise, there may be little or no change in the audio level. For additional information on AudioPilot, visit www.bose.com/audiopilot.

To use this feature, set the volume to the desired level and then press ON. To turn it off, select OFF.

Preset selection: This feature programs local presets that are recalled by pressing HOME. Presets can also be programmed while traveling to another area and can be stored under the AWAY setting. See “Preset Station Menu” later in this section.

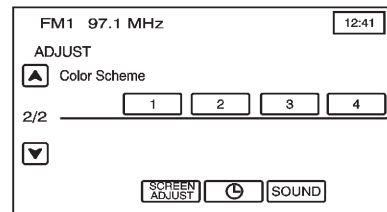

Color Scheme: Select this feature to change the color of audio and navigation screens. Press any of the

14 Infotainment System

color options to view the different backgrounds. Color option 1 is the default option.

Clock

Press  at the bottom of the audio/adjust screen or press and hold the time display in the upper right corner of any menu to access the CLOCK ADJUST menu. Pressing the time display also displays the date on the status bar at the top of the screen.

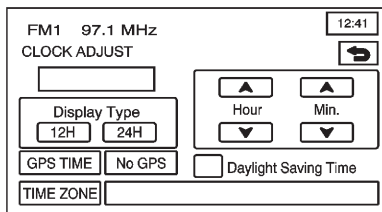

The following time options can be adjusted from this menu:

Hour/Min.:

- Press the up or down arrows to increase or decrease the hour or minutes.
- Press and hold either arrow to advance quickly.

12H/24H: Press 12H to display the time in standard time, or 24H to display the time in military time.

GPS TIME: The current GPS time is displayed to the right of this button. Press GPS TIME to set the navigation system's time to match current GPS time.

Daylight Saving Time: Press this screen button to increase the time setting by one hour, then press GPS TIME to save the new setting. If the screen button is light blue, the daylight savings time feature is on. If the screen button is dark blue, the daylight savings time feature is off.

TIME ZONE: The selected time zone appears to the right of this screen button. Press TIME ZONE to toggle through the available time zones until the desired time zone is highlighted. The time of the selected zone is displayed to the right of GPS TIME. To set the system clock to the new setting, press GPS TIME.

If the system is not receiving GPS information, the time can still be set manually as described above, but GPS TIME and Daylight Saving Time features are not available.

Press the back screen button to go back to the previous menu.

Screen Adjust

To adjust the contrast or brightness of the screen, press SCREEN ADJUST at the bottom of the audio/adjust screen.

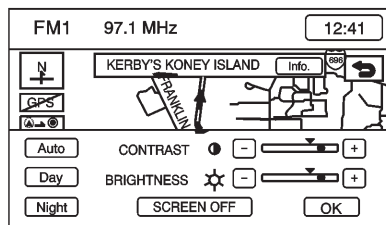

The following screen options can be adjusted from this menu:



CONTRAST: Press + or – to adjust the contrast. The screen changes. Press OK to confirm the change.

BRIGHTNESS: Press + or – to adjust the brightness. Press OK to confirm the change.

AUTO: This setting automatically adjusts the contrast and brightness of the screen based on outside lighting conditions.

DAY: This setting leaves the screen in day mode, which is best suited for daylight conditions.

NIGHT: This setting leaves the screen in night mode, which is best suited for nighttime conditions.

SCREEN OFF: Press to turn off the screen. Press the NAV, SRCE, or  /  (Audio/Adjust) control buttons to turn the screen back on.

OK: Press to save changes and exit this menu.

SOUND: Press to access the SOUND menu. See “Sound Menu” later in this section.

Finding a Station

Press SRCE to display the operation screen of the current audio source. Each operation screen has an audio source screen button, (AM, FM1, FM2, XM1, XM2, if equipped, and CD). Press the desired audio source to select it.

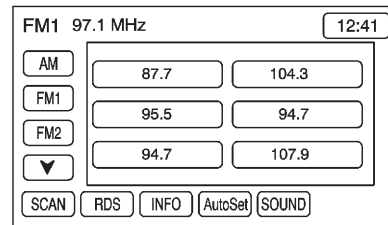

Preset Station Menu

Up to 30 stations, six AM, six FM1, six FM2, six XM1, and six XM2, if equipped, can be programmed for home and for away (XM does not have the home and away feature). To store presets:

1. Turn the audio system on.
2. Press SRCE.
3. Press AM, FM1, FM2, XM1, or XM2, if equipped, to display the desired source. The preset station menu appears.

16 Infotainment System

4. Tune to the desired station by using ▲ □ SEEK ▼.
5. Press SOUND to set the bass, mid-range, treble, and Auto Tone Control (ATC) for the preset, if desired. See “Sound Menu” later in this section.
6. Press and hold one of the six numbered preset screen buttons for more than two seconds until a beep is heard.
7. Repeat the steps for each preset and source.

SCAN:

- Press to scan stations. The radio goes to a station, plays for a few seconds, then goes to the next station.
- Press SCAN again to stop scanning.
- Press and hold SCAN for two seconds to scan preset stations. It will only scan the audio source it is in, with the

exception of FM 1 and FM 2, which will both be scanned if in that source.

- Press SCAN again to stop scanning.

RDS (Radio Data System): See “Radio Data System (RDS)” in this section.

INFO (Information): See “Radio Data System (RDS)” in this section.

AutoSet:

1. Press this screen button to replace currently stored preset stations with the strongest stations available in the immediate area.
2. Press it again to return to the original preset stations.

SOUND: See “Sound Menu” following in this section.

Sound Menu

Press SOUND at the bottom of the main audio screen or source menu to change the tone, ATC, fade, and

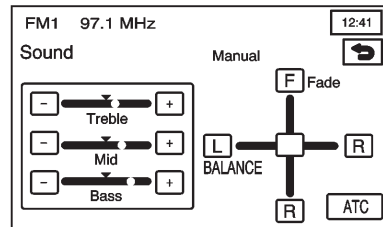

balance for all sources. The audio system has a separate setting for these features for each source preset. However, the audio system keeps one fade and one balance setting for all audio sources.



To adjust sound settings:

- Press the + or – signs to adjust TREBLE, MID (Mid-range), and BASS, if in the Manual mode of ATC.
- Press the L (Left) or R (Right) to adjust the balance of the speakers.

- Press the F (Front) or R (Rear) to adjust the fade of the speakers.
- Press the ATC screen button to adjust the ATC setting. See “Adjusting the Speakers” later in this section.

After adjustments are made, press  to go back to the preset station menu. Whenever  is pressed, the previously stored information that was entered for each preset station is recalled.

Adjusting the Speakers

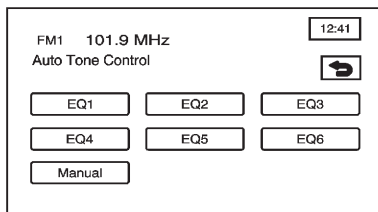

ATC (Auto Tone Control): The ATC feature is used to provide a choice of six different listening experiences. ATC can be used while listening to the audio system or the CD player. The audio system can store separate ATC settings for each source and preset station.

To save ATC settings for the preset stations, use the SOUND menu and press ATC. See “Preset Stations” earlier in this section.

Radio Data System (RDS)

The audio system has a Radio Data System (RDS). RDS features are available for use only on FM stations that broadcast RDS information. With RDS, the radio can:

- Seek to stations broadcasting the selected type of programming.
- Receive announcements concerning local and national emergencies.
- Display messages from radio stations.
- Seek to stations with traffic announcements.

RDS (Radio Data System): Press RDS to use alternate RDS functions located in the preset menu. After pressing RDS, quickly choose RDS ON/OFF, TA, INFO, PTY, or Select PTY. If a selection is not made, the system returns to the previous menu.

18 Infotainment System

If tuned to a station broadcasting RDS information, the station's Program Service (PS) and Program Type (PTY) replace the station's frequency on the status line at the top of the display. After about five seconds, if available, the PTY is replaced on the display by the station's PTY name. The PTY and PTY name can be the same or different.

If the audio system is tuned to a station that is not broadcasting RDS information, the station's frequency remains on the display.

The RDS feature relies upon receiving specific information from RDS stations. These features only work when RDS information is available.

TA (Traffic Announcement): Press TA to receive traffic announcements. TA displays if the current station broadcasts traffic announcements. If the current station does not broadcast traffic announcements, the audio system

seeks to a station that does and stops. If no station is found, TA turns off.

While a traffic announcement plays, the audio system uses TA volume. To increase TA volume, use the VOL up or down buttons during the announcement. See "Guidance Volume" under *Navigation Set Up on page 54*.

When a traffic announcement comes on the current radio station, it can be heard even if the volume is muted or a CD is playing. If the CD player was being used, the CD stays in the player and resumes play at the point where it stopped.

Press RDS followed by TA again to turn TA off.



INFO (Information): When RDS is on, if the current station has a message, INFO displays. Press INFO from the preset menu to view the message. If the whole message does not display, parts of the message appear every three seconds until the message is

completed. Once the complete message has been displayed, INFO disappears from the display until another new message is received. INFO remains available so that the entire message can be displayed again.

PTY (Program Type): PTY only seeks stations with certain program types. This button is used to turn on and off Program Type (PTY) features.

With RDS on, press RDS, followed by PTY. The PTY display turns on. Press RDS followed by this button again to turn the PTY display off.

Select PTY (Select Program Type): With RDS and PTY on, press RDS, then Select PTY. The PTY menu appears. Use the up and down arrows to select a PTY.

When the PTY display is on, press   SEEK  or SCAN to find radio stations of the PTY selected. The last PTY selected is used for seek and scan modes. If a station with the selected PTY is not found,

STATION NOT FOUND displays. If both PTY and TA are on, the audio system searches for stations with traffic announcements and the selected PTY.

PTY (Program Type) Presets: The six presets let you return to your favorite PTYs. These presets have factory PTY preset stations. Up to 12 PTYs, six FM1 and six FM2 can be set. To save a PTY preset:

1. Press FM1 or FM2.
2. Press RDS to enter the RDS menu.
3. Press RDS ON/OFF to turn RDS on.
4. Press PTY.
5. Press Select PTY and select the desired PTY from the list.
6. Press and hold one of the six presets for more than two seconds until a beep is heard. When you press that numbered preset for less than two seconds, the set PTY returns.

7. Repeat the steps for each preset.

Press the stored PTY preset station for less than two seconds to recall it. Then use ▲ □ SEEK ▼ or SCAN to locate a station for that PTY selection.

ALERT: This type of announcement warns of national or local emergencies and cannot be turned off. ALERT displays while an alert announcement plays. The audio system uses TA volume during these announcements. To increase volume, use the VOL up and down buttons during the announcement. See “Voice Guidance Volume Settings” under *Navigation Set Up on page 54*. When an alert announcement comes on the tuned radio station, it will be heard even if the volume is muted or a CD is playing. If the CD player is playing, the player stops for the announcement and resumes when the announcement is finished.

Home and Away Preset Stations

If the vehicle has this feature, the audio system settings that were adjusted the last time the vehicle was operated can be recalled. This feature allows two different drivers to store and recall their own audio system settings. The adjusted settings are recalled by the audio system and are determined by which Remote Keyless Entry (RKE) transmitter (1 or 2) that was used to enter the vehicle. The number on the back of the RKE transmitter corresponds to driver 1 or to driver 2.

The audio system can store HOME and AWAY preset stations. HOME and AWAY preset stations allow the use of one set of preset radio settings in a local area, and another set not in the local broadcast area. This eliminates the need to reprogram preset stations while traveling out of the area.

To select HOME and AWAY preset stations:

1. Press AUDIO to enter the audio screen.
2. Press the HOME or AWAY button.

The next time the audio system is turned on, the system recalls the last active preset selection.

If the vehicle loses battery power, the local preset stations do not have to be reset. However, the non-local preset stations must be reset.

Satellite Radio

XM™ Satellite Radio Service

XM is a satellite radio service based in the 48 contiguous United States and 10 Canadian provinces. XM Satellite Radio has a wide variety of programming and commercial-free music, coast to coast, and in digital-quality sound. During your trial or when you subscribe, you will get unlimited access to XM Radio Online for when you are not in the

vehicle. A service fee is required to receive the XM service. For more information, contact XM at www.xmradio.com or 1-800-929-2100 in the U.S., and www.xmradio.ca or 1-877-438-9677 in Canada.

INFO (Information): Press INFO while in XM mode to retrieve various pieces of information related to the current song or channel. By pressing INFO, four different categories of information can be retrieved that cycle through: Artist Name/Feature, Song/Program Title, Channel Category, and other Additional Information that may be broadcast on that channel. Additional Information messages may only be available at certain times or on certain programs. If an Additional Information message is being broadcast on the tuned channel, INFO displays.

Each of the four information types may have multiple pages of text. To reach a category, press INFO once and wait until the desired type

displays. If there are multiple pages of text for the selected information type, the radio automatically displays all the pages for that type at a rate of about one page every three seconds before timing out and returning to the default display.



XM™ Radio Messages

See “XM™ Radio Messages” in the owner manual for a list of possible XM messages.

Audio Players

CD Player

To load/eject a music CD:

1. Turn the ignition on.
2. Press . This opens the faceplate of the system.
3. Press . If a CD is already loaded, the CD ejects from the slot.
4. Gently remove the CD from the slot and return it to its case.
5. Insert the music CD into the slot. The system pulls the disc into the player.
6. Press and release  to close the faceplate.

When the faceplate is opened, a warning message displays as a reminder to close the faceplate as soon as possible.

Playing a CD

Once a music CD is loaded, the CD player menu displays.

If the ignition or radio is turned off while a CD is in the player, it stays in the player. When the ignition or radio is turned on, the CD starts to play where it stopped, if it was the last selected audio source.

As each new track starts to play, the track number displays.

The CD player can play the smaller 8 cm (3 in) single CDs with an adapter ring. Full-size CDs and the smaller CDs are loaded in the same manner.

If playing a CD-R the sound quality can be reduced due to CD-R quality, the method of recording, the quality of the music that has been recorded, and the way the CD-R has been handled. There can be an increase in skipping, difficulty in finding tracks, and/or difficulty in loading and ejecting. If these problems occur, check the bottom

surface of the CD. If the surface of the CD is damaged, such as cracked, broken, or scratched, the CD does not play properly. If the surface of the CD is soiled, take a soft lint free-cloth, or dampen a clean soft cloth in mild detergent solution mixed with water, and clean it. Make sure the wiping process starts from the center to the edge.

If there is no apparent damage, try a known good CD.

Notice: If a label is added to a CD, more than one CD is inserted into the slot at a time, or an attempt is made to play scratched or damaged CDs, the CD player could be damaged. While using the CD player, use only CDs in good condition without any label, load one CD at a time, and keep the CD player and the loading slot free of foreign materials, liquids, and debris.

22 Infotainment System

A CD with a label could get caught in the CD player. If a description label is needed, label the top of the CD with a soft marker.

If an error displays, see “CD Errors” later in this section.

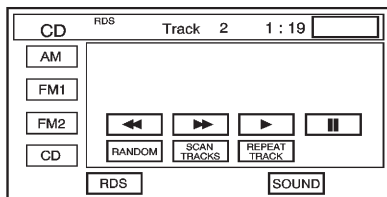

▶ (Play): Press to begin playing a CD.

RANDOM:

1. Press to hear the tracks in random, rather than sequential order on the current CD.

2. Press **▲** **SEEK** **▼** to randomly seek through the tracks on this CD.
3. Press **RANDOM** or **RANDOM DISC** again to turn off random play.

SCAN TRACKS:

1. Press to hear the first 10 seconds of each track on the current CD.
2. Press again to stop scanning. The CD mutes while scanning.

REPEAT TRACK: Press to repeat the selected track. Press again to turn off repeated play.

◀ (Rewind): Press to rewind quickly through a track selection.

▶ (Forward): Press to fast forward quickly through a track selection.

▲ **SEEK** **▼** :

1. Press **▲** to seek to the next selection on the CD. If playing the last track of the disc, press **▲** to seek to the first track of the disc.
2. If playing the first track of the disc, press **▼** to seek to the last track of the disc. The sound mutes while seeking.
3. Press either **▲** or **▼** to change the tracks on an iPod for playback.

|| (Pause):

1. Press to pause CD play.
2. Press it again to resume play or press the play button.

Playing a CD Changer

If the vehicle has the CD changer, it can play up to six discs. Normal size discs may be played using the trays supplied in the magazine. The

smaller 8 cm (3 in) discs can be played only with specially designed trays.

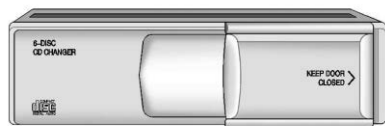

The magazine must be loaded with CDs before one can play. Each of the six trays holds one CD.

Load the trays from bottom to top, placing a disc in the tray label side up. If a CD is loaded with the label side down, the disc does not play and an error occurs. Repeat this procedure for loading up to six discs in the magazine.

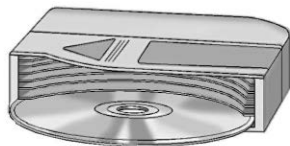

Once you have loaded the discs into the magazine, slide the CD changer door open. Push the magazine into the changer in the direction of the arrow marked on top of the magazine.

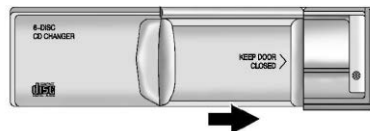

Close the door by sliding it all the way to the right. When the door is closed, the changer begins checking for discs in the magazine. This continues for up to one and a half minutes, depending on the number of discs loaded. Noise might be heard, but this is normal. The CD changer is initializing.

To eject the magazine from the player, slide the CD changer door all the way open. Press EJECT, located inside of the changer door, and the magazine ejects.

Remember to keep the door closed whenever possible to keep dirt and dust from getting inside the changer.

To eject CDs from the magazine, push the RELEASE switch on the bottom of the magazine.

Press the CD control button to access the six-disc CD changer screen. The system's DVD player for single CD play can also be used once the map DVD is removed.

If no CD is loaded in the CD/DVD Player and CD is pressed, the message "No CD loaded" displays.

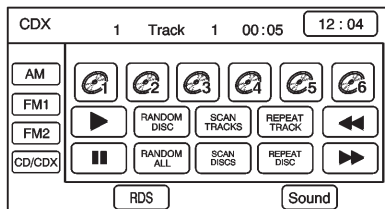

CD Changer Screen

The numbered buttons, 1 through 6, represent the order of the CDs loaded in the changer. If there are only two CDs loaded, only buttons 1 and 2 are available to choose from.

Many of the buttons described previously in the “Playing a CD” section have the same function as the CD changer buttons. See “Playing a CD” earlier, for button description.

Some of the buttons that are specific to the CD changer are:

RANDOM ALL:

1. Press to hear the tracks, on all of the loaded CDs in the CD changer, in random, rather than sequential order.
2. Press **▲** **□** **SEEK** **▼** while RANDOM ALL is on to randomly seek within that CD.
3. Press RANDOM ALL again to turn off random play.

SCAN DISCS:

1. Press to hear the first 10 seconds of first track on each loaded CD.
2. Press again to stop scanning. The CD mutes while scanning.

REPEAT DISC:

1. Press to repeat the selected CD.
2. Press REPEAT DISC again to turn off repeat play.

▲ **□** **SEEK** **▼** :

1. Press **▲** to seek to the next selection on the CD. If playing the last track of the CD, press **▲** to seek to the first track of the next CD.
2. Press **▼** to seek to the previous selection on the CD. If playing the first track of the CD, press **▼** to seek to the last track on the selected CD. The sound mutes while seeking.

Using an MP3

MP3 Format

When creating an MP3 disc, the following is a list of guidelines. If these guidelines are not followed while recording a CD-R(W), the CD may not play.

- ID3 tag information is displayed by the radio if it is available. The radio supports ID3 tag information v1.0 or v1.1. The

radio displays a filename, song name, artist name, album name, and directory name.

- A Maximum of 31 characters, including spaces, in a file or folder name.
- Maximum number of folders is 500 with 500 files with a maximum hierarchy of eight folders. It is recommended to keep the depth of folders to a minimum in order to keep down the complexity and confusion in trying to locate a particular folder during playback.
- Create a folder structure that makes it easy to find songs while driving. Organize songs by albums using one folder for each album. Each folder or album should contain 18 songs or less.
- The files can be recorded on a CD-R or CD-RW with a maximum capacity of 700MB.
- DVD with MP3 are not playable on this system.

- The radio does not play a mixed mode CD-R/RW, a disc recorded with both *.cda and *.mp3 files.
- The player supports a disc with multiple sessions, but it is not required that the disc be finalized. It is recommended to record the disc all at once.
- Recording format mode 2 or mode 2XA with Romeo or Joliet file system is not supported with this player.
- All applicable Mode 1 recording formats are supported.
- MPEG 2.5 is not supported with this player. File formats MPEG 1 and MPEG 2 with all bit rates (including variable) except less than 16kbps are supported with this player.
- Long files or folder names or a combination of a large number of files and folders could cause the player to be unable to play up to the maximum number of files or folders or affect the reading speed and time to play.

Playing an MP3

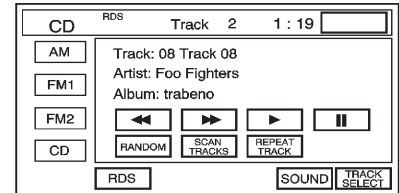

CD Display Shown, MP3 Display Similar

Many of the buttons described previously in the “Playing a CD” section have the same function as the MP3 buttons. See “Playing a CD” earlier, for button description.

Some of the buttons specific to playing an MP3 are:

TRACK SELECT:





1. Select to display the MP3 folder/ file structure.

2. Use the up/down arrows to scroll through the list.
3. Select the folder or track to play.
Press  to go back to the main screen.

HOME: Select to go to the Home folder. This is the folder on the disc that contains the current track that is playing.

 **(Folder Up):** Select to go to the previous folder.

  **SEEK**  :

1. Press  to seek to the next track on a disc. If playing the last track, press  to seek to the first track of the current folder.
2. Press  to go to the beginning of the current track or to the previous track on a disc. If playing the first track, press  to seek to the last track of the current folder.

CD Errors

CD ERROR could display for the following:

- The road is too rough. The CD should play when the road is smoother.
- The CD is dirty, scratched, wet, or not loaded label side up.
- The air is very humid. If so, wait about an hour and try again.

If any error occurs repeatedly or if an error cannot be corrected, contact your dealer.

Vehicles with audio controls have some controls that can be adjusted at the steering wheel. See “Steering Wheel Controls” in the owner manual.

Connecting a USB Storage Device or iPod®

The USB port, located in the center console, can be used to control an iPod or a USB storage device.

To avoid connection problems, extension cords are not recommended. Use only the cable that came with the device.

To connect a USB storage device, connect the device to the USB port located in the center console.

To connect an iPod, connect one end of the USB cable that came with the iPod to the iPod’s dock connector and connect the other end to the USB port. If the vehicle is on and the USB connection works, “OK to disconnect” may appear on the iPod and iPod appears on the radio’s display. The iPod music appears on the radio’s display and begins playing.

The iPod charges while it is connected to the vehicle if the ignition is on or in the accessory position. When the vehicle is turned off, the iPod automatically powers off and will not charge or draw power from the vehicle’s battery.

USB Supported File and Folder Structure

The guidelines that must be met while using USB supported files and folders are:

- Up to 699 folders.
- Up to eight folders in depth.
- Up to 65,535 files.
- Folder and file names up to 64 bytes.
- Files with an .mp3, .wma, or .m4a file extension.
- AAC files stored on an iPod.
- FAT16.
- FAT32.

Some files may restart at the beginning of the track after the vehicle has been turned off and then turned back on again.

Playing from an iPod®

This feature supports the following iPod models:

- iPod (5th generation)

- iPod nano® (1st generation)
- iPod nano (2nd generation)
- iPod nano (3rd generation)
- iPod nano (4th generation)
- iPod classic®
- iPod touch®

Video streaming or album art will not be supported from the iPod.

For proper operation, make sure the iPod has the latest firmware from Apple®. iPod firmware can be updated using the latest iTunes® application.

For more information, visit www.apple.com/itunes

To connect and control an iPod, connect one end of the standard iPod USB cable to the iPod's dock connector. Connect the other end to the USB port, located in the center console.

iPod music information displays on the radio's display and begins playing through the vehicle's audio system.

The iPod battery recharges automatically while the ignition is on or in the accessory position. When the ignition is turned off while an iPod is connected using the iPod USB cable, the iPod battery stops charging and the iPod automatically turns off.

If the iPod is a model that is not supported, it can still be listened to in the vehicle by connecting it to the auxiliary input jack using a standard 3.5 mm (1/8 in) stereo cable. See *Auxiliary Devices on page 30*.

iPod Music Menu

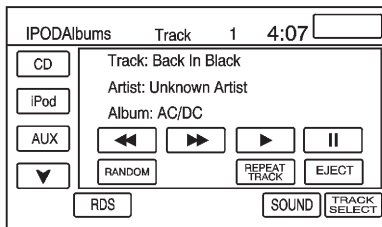

Once the iPod has been connected, the main music menu appears.

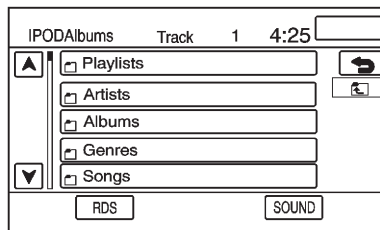

Press TRACK SELECT to display the available selections:

Playlists:

1. Press to view the playlists that have been stored on the iPod.
2. Select a playlist name to view a list of all songs in the playlist.
3. Select the desired song from the list. Once a song has been selected, the Folder Up screen button will, return you to the previous screen. The small return arrow located on the upper right side of the main

screen, under the Folder Up screen button will return you to the iPod main menu.

Artists:

1. Press to view the artists that have been stored on the iPod.
2. Select an artist name to view a list of all songs by the artist.
3. Select the desired song from the list. Once a song has been selected, the Folder Up screen button, will return you to the previous screen. The  located on the upper right-side of the main screen, under the Folder Up screen button will return you to the iPod main menu.

Albums:

1. Press to view the albums that have been stored on the iPod.
2. Select an album name to view a list of all songs on the album.
3. Select the desired song from the list. Once a song has been selected, the Folder Up screen

button, will return you to the previous screen. The  located on the upper right side of the main screen, under the Folder Up screen button, will return you to the iPod main menu.

Genres:

1. Press to view the genres that have been stored on the iPod.
2. Select a genre name to view a list of all songs of that genre.
3. Select the desired song from the list. Once a song has been selected, the Folder Up screen button, will return you to the previous screen. The  located on the upper right side of the main screen, under the Folder Up screen button, will return you to the iPod main menu.

Composers:

1. Press to view the composers that have been stored on the iPod.

2. Select a composer name to view a list of all songs of that composer.
3. Select the desired song from the list. Once a song has been selected, the Folder Up screen button, will return you to the previous screen. The  located on the upper right side of the main screen, under the Folder Up screen button, will return you to the iPod main menu.

Songs:

1. Press to view a list of songs that have been stored on the iPod.
2. Select the desired song from the list. Once a song has been selected, the Folder Up screen button, will return you to the previous screen. The  located on the upper right side of the main screen, under the Folder Up screen button, will return you to the iPod main menu.

Podcasts:

1. Press to view the podcasts that have been stored on the iPod.
2. Select a name to view a list of all podcasts of that genre.
3. Select the desired podcast from the list. Once a podcast has been selected, the Folder Up screen button will return you to the previous screen. The  located on the upper right side of the main screen, under the Folder Up screen button, will return you to the iPod main menu.

Podcasts will only appear as a valid category if this option is on the iPod.

Eject iPod: Press to remove the iPod. If the iPod is disconnected without selecting this button, the files on the iPod could be corrupted.

Auxiliary Devices

The navigation system has an auxiliary input jack located on the right side of the faceplate. This is not an audio output; do not plug the headphone set into the front auxiliary input jack. You can, however, connect an external audio device such as an iPod, laptop computer, MP3 player, CD changer, or cassette tape player, etc. to the auxiliary input jack for use as another source for audio listening.

Drivers are encouraged to set up any auxiliary device while the vehicle is in P (Park). See “Defensive Driving” in the owner manual for more information on driver distraction.

If the vehicle has rear audio/video input jacks, located in the rear of the center console, they can be used as another source for audio/video listening.

To use a portable audio player, connect a 3.5 mm (1/8 in) cable to the auxiliary input jack. When a

device is connected, the system will detect and automatically begin playing audio from the device over the vehicle's speakers.

If a device is connected and you are listening to another source (FM, CD, MP3, etc.), press the AUX screen button located on the left side of the screen. If AUX is not a selection, press the down arrow until the AUX screen button does appear.

Navigation

Using the Navigation System

This section has basic information on how to operate the navigation system.

Use the buttons located on the navigation system along with the available touch-screen buttons on the navigation screen to operate the system. See *Overview on page 4*.

Once the vehicle is moving, some functions are disabled to reduce driver distractions.

Navigation Buttons

The following buttons are located on the faceplate of the navigation system:

 **(Open/Close Faceplate):** Press this button, located at the bottom of the Navigation Screen, to open or close the faceplate.

 **(Eject CD):** Press the eject CD button, located next to the CD loading slot, to eject CDs. See *CD Player on page 21*.

 **DVD (Eject Map Database DVD):** Press this button, located next to the DVD loading slot, to eject the map DVD. See “Installing the DVD Map Disc” under *Maps on page 63*.

Power/Volume Knob: Press to turn the audio and navigation systems on and off. Turn to increase or decrease the volume to the audio system.

 **(Voice Recognition):** Press to activate the voice recognition system. See *Voice Recognition on page 73*.

NAV (Navigation): Press to access the map screen. If this button is pressed when a map screen is displayed and while in route guidance, the system repeats the last voice command.

SRCE (Source): Press to access the audio source screen. See *AM-FM Radio on page 12* or *Satellite Radio on page 20*.

 **(Audio/Screen Adjust):** Press to access the Audio Adjust and Screen Adjust screens. See *AM-FM Radio on page 12* or *Satellite Radio on page 20*.

 **SEEK** : Press the arrows to go to the next or previous radio station and stay there, or to tune in a station. See *AM-FM Radio on page 12* or *Satellite Radio on page 20*.

Alpha-Numeric Keypad

Letters of the alphabet, symbols, punctuation, and numbers are displayed on the navigation screen as an alpha or numeric keypad. The alpha keypad displays when a city or street name needs to be entered. Touch the Sym. (symbol) screen button at the bottom of the alpha keypad to access the numeric keypad when entering a house

address, punctuation mark, or other character. Touch A–Z to return to the alpha keypad.

All characters are touch-sensitive screen buttons. Touch a character to select it.

 **(Space):** Press to enter a space between characters or the words of a name.

 **(Back space):** Press if an incorrect character has been selected.

To make name selections easier, the system only lets you select a character that can follow the last one entered. For example, if a Z is entered, a T is not available to select. The system highlights the available characters.

If a name does not display after it is entered, it may need to be entered differently, the map DVD database may not contain that information, or the correct search area has not been selected. See *Database Coverage Explanations on page 73*.

Touch-Sensitive Buttons

Touch-sensitive buttons are located on the screen. When a screen button has been selected, a beep sounds. These buttons are highlighted when a feature is available. There are also some toggle screen buttons that are light in color when active.

Keyless Access System

When the vehicle is started, Driver 1 or Driver 2 displays on the Driver Information Center (DIC). The number on the back of the RKE transmitter corresponds to Driver 1 or Driver 2. The navigation system can store memory points, audio presets, system settings, and last known audio mode for Driver 1 and Driver 2 individually. See “Vehicle Personalization” in the owner manual.

Enter Destination

Press  (Enter Destination) to access the ENTER DESTINATION screen. From this screen, several options are available to plan a route by entering destination points.

Once a destination entry is complete, regardless of which method used, a map screen with the destination previewed displays.

- Change route preferences, route options, or map appearances, or add a waypoint at this time.
- Set the destination without making any further changes. See “Getting Started on Your Route” in this section on your choices once a destination has been entered.

This menu has two pages. To view the second page, press the 1/2 arrow button.

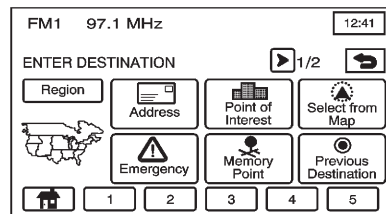

Region

The ENTER DESTINATION screen displays a map of the United States and a part of Canada divided into 11 regions.

Before selecting a destination entry method, review the search area map to make sure your destination is located in the highlighted region.

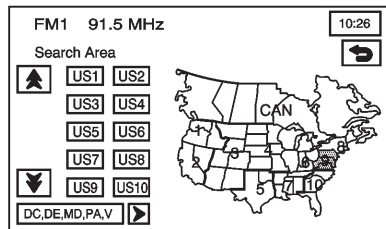

1. Press Region from the ENTER DESTINATION screen to see a list of states included in the highlighted region, or to change the region. The SEARCH AREA screen displays.
2. Press the numbered screen button to the left of the search area map that corresponds with the numbered region you wish to select or to view a list of states included in that region.

3. Press the down arrow to the left of the search area map to select CAN (Canada). Once the region has been selected, the region is highlighted on the map.

4. Press  to return to the ENTER DESTINATION screen.

Address

The address destination entry method lets you enter an address by providing the system with a street name or city.

 **(Address):** Press to access the ADDRESS screen. Enter the address one of two ways: street first or city first.

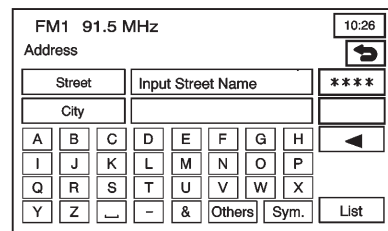

To enter the street name first:

1. Press the Street screen button from the address menu and start entering the street name using the alpha keypad. A list of five or fewer available street names automatically displays. Press the List screen button at any time to view the available street names. The box at the end of the Street entry field contains the number of street names available in the current generated list.

34 Infotainment System

2. Select the desired street name with the correct designation (Dr., Ln., St., etc.) from the list.
3. If the system determines that the street is found in only one city within the search area, that city automatically is selected.

If there is more than one city, the system displays the list of cities that have a street with that name. Select a city from the list or select the Input Name screen button to enter the city name.

4. The house number screen displays. Enter the house number using the numeric keypad.
5. Once the correct house number is selected, press OK.
6. Press  (Destination).
7. Press the Guide screen button.

See “Getting Started on Your Route” in this section.

To enter the city name first:

1. Press the City screen button.
2. Select from the choices shown on the city screen: Any City, 5 Nearest Cities, or Input City Name, or from the Last 5 Cities used.
 - Any City — The system requests input of a street name, then generates a list of all cities containing that street name. Select a city from the list.
 - 5 Nearest Cities — The system displays a list of five cities closest to your vehicle's current position. Select a city from the list.
 - Input City Name — The keypad displays for entering the city name. Enter the city name and then select the city from the list.

- Last 5 Cities — The city names of the last five cities that were stored as a previous destination displays. Select a city from the list.
3. The screen to input the street name and house number displays. Input the street name using the alpha keypad. A list of available street names displays if there are less than five street names available. Select the List screen button at any time to view the available street names. The box at the end of the Street entry field contains the number of street names available in the current generated list.
 4. Select the desired street name with the correct designation (Dr., Ln., St., etc.) from the list.
 5. The house number screen displays. Enter the house number using the numeric keypad.

Once the correct house number is selected, a map screen appears with the destination marked.

6. Press .
7. Press the Guide screen button.

See “Getting Started on Your Route” in this section.

Point of Interest (POI)

The Point of Interest (POI) destination entry method lets you select a destination from the POI list.

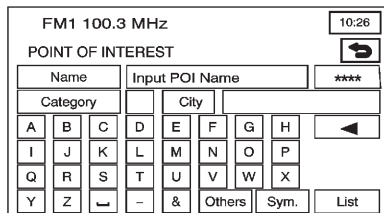

 **(Point of Interest):** Press this screen button from the ENTER DESTINATION screen to access the POINT OF INTEREST screen. This screen has three options to select/input the destination. Either enter the name of the POI using the alpha keypad, select a category from the category list, or select the city by selecting the City screen button.

To input the POI name:

1. Use the alpha keypad to enter the POI name.

Press Sym. (symbol) to select symbols and numbers for the POI, press Others to select special characters for the POI, or press A–Z to return to the alpha keypad.

A list of POIs appears using the information from the alpha keypad input. A list of available POIs displays when there are less than five POIs available. Press the List screen button at any time to view the available POIs.

2. Select the desired POI from the list.
3. If the system determines that the POI is found in only one city within the search area, that city automatically is selected.

If there is more than one city, the system displays the list of cities that have a POI with that name. Select a city from the list or select the Input Name screen button to input the city name.

Once all of the information is selected, a map screen appears with the destination marked.

4. Press .
5. Press the Guide screen button.
See “Getting Started on Your Route” in this section.

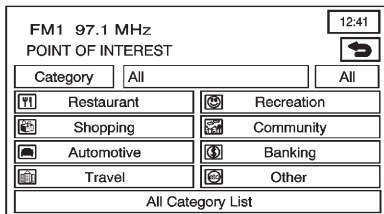

To select a POI from a category:

1. Press Category from the POINT OF INTEREST screen to view a list of POI categories.
2. Select a category, and then a sub-category.

3. The system displays available POIs in the selected sub-category, or if the list is too long, the system displays the alpha keypad.
4. If the alpha keypad is displayed, input the POI name until a list of available POIs appears.
5. Select the POI from the list.
6. If the system determines that the POI is found in only one city within the search area, that city automatically is selected.

If there is more than one city, the system displays the list of cities that have a POI with that name. Select a city from the list or select the Input Name screen button to enter the city name.

Once all of the information is selected, a map screen appears with the destination marked.

7. Press .
8. Press the Guide screen button.

See “Getting Started on Your Route” in this section.

To select a POI by entering a city name:

1. Select the City screen button, then select: Any City, 5 Nearest Cities, Input City Name, or from the Last 5 Cities used.
 - Any City — The system requests input of a POI name, then generates a list of all cities containing that POI name. Select a city from the list.
 - 5 Nearest Cities — The system displays a list of five cities closest to your vehicle's current position. Select a city from the list.
 - Input City Name — The keypad displays for entering the city name. Enter the city name and then select the city from the list.

- Last 5 Cities — The city names of the last five cities that were stored as a previous destination display. Select a city from the list.
2. Use the alpha keypad to enter the POI name.

Press Sym. (symbol) to select symbols and numbers for the POI, press Others to select special characters for the POI, or press A–Z to return to the alpha keypad.

3. A list of POIs appears using the information from the alpha keypad input. A list of available POIs displays when there are fewer than five POIs available. Press the List screen button at any time to view the list of available POIs.
4. Select the desired POI from the list.

A map screen appears with the destination marked.

5. Press .
6. Press the Guide screen button.
See “Getting Started on Your Route” in this section.

Map

The map destination entry method lets you select a destination by scrolling on the map.

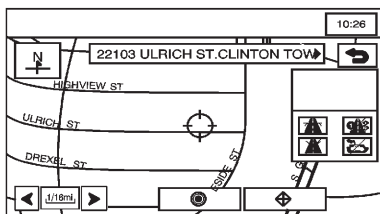

 **(Select from Map):** Press this button from the ENTER DESTINATION screen to enter the map destination entry method, then do the following:

1. Press the map for the desired area of the destination.
2. Use the zoom in/out function to view the direction of the desired area.
3. Pressing/holding and dragging on the map activates fast scrolling. Press once on the area where the current position mark should be moved.

Once the scroll symbol is on the location, the address information displays on the map screen.

4. Press .
5. Press the Guide screen button.
See “Getting Started on Your Route” in this section.

Emergency

The emergency destination entry method allows a destination to be entered from three categories: Police Station, Hospital, or Dealer.

FM1 100.3 MHz	10:26
EMERGENCY	
Current Position	943 E CAPITOL ST NE WASHINGTON, DC LAT. N38°53'23" LONG W76°59'35"
<input type="button" value="Police Station"/>	
<input type="button" value="Hospital"/>	
<input type="button" value="Dealer"/>	

 **(Emergency):** Press this button from the ENTER DESTINATION screen to access the EMERGENCY screen. The system displays the address, longitude, and latitude information of the vehicle's current position.

To use this destination entry method:

1. Select a category. A list of destination(s) display with the name of the destination and the distance from the vehicle's current position.
2. Select a destination point from the list. Press Name Sort to sort the list by name, or Dist Sort to sort the list by distance from the vehicle's current position.

After selecting a destination from the list, a map screen appears with the destination marked.

3. Press .
4. Press the Guide screen button.
See "Getting Started on Your Route" in this section.

Memory Points

The memory points destination entry method allows selection of a destination from a list of points that have been previously stored.

To store, edit, and delete memory points see *Stored Locations on page 45*.

FM1 97.1 MHz	12:41
MEMORY POINTS	
<input type="button" value="Del. All"/>	
<input type="button" value="PERSONAL"/>	
<input type="button" value="BUSINESS"/>	
<input type="button" value="ENTERTAINMENT"/>	
<input type="button" value="MARKED POINT"/>	

 **(Memory Point):** Press this button from the DESTINATION ENTRY screen to access the MEMORY POINTS screen.

To use this destination entry method:

1. Select the category/folder in which the memory point has been stored. Select from

PERSONAL, BUSINESS, ENTERTAINMENT, or MARKED POINT folders.

- Sort the list by distance, icon, name, or date stored.
- Select the desired memory point.

After selecting a memory point from the list, a map screen appears with the destination marked.

- Press .
- Press the Guide screen button.
See “Getting Started on Your Route” in this section.

Previous Destination

The previous destination entry method lets you select a destination from a list of previous destination points.

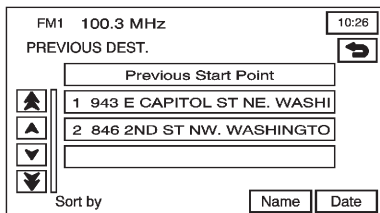

 (Previous Destination): Press this button from the ENTER DESTINATION screen to access the PREVIOUS DEST screen. The system stores up to 100 points that have been previously input. As new destinations are entered, the system automatically deletes the oldest destinations and adds the new entries.

To use the previous destination entry method:

- Select a previous destination from the list. Use the Sort by Name/Date function as necessary. Also from this menu the previous start point option can be selected. This option is available while the vehicle is moving.

To use the previous start point option from the PREVIOUS DEST screen, press the Previous Start Point screen button.

- After selecting a destination from the list, a map screen appears with the destination marked.
- Press .
- Press the Guide screen button.
See “Getting Started on Your Route” in this section.

Intersection

The intersection destination entry method allows two intersecting streets to be set as the destination.

FM1 100.3 MHz										10:26
INTERSECTION										
1st St.		Input first Street Name							****	
2nd St.										
A	B	C	D	E	F	G	H			
I	J	K	L	M	N	O	P			
Q	R	S	T	U	V	W	X			
Y	Z		-	&	Others	Sym.	List			

+ (Intersection): Press this button from the ENTER DESTINATION screen to access the INTERSECTION screen.

To use this destination entry method:

1. Enter the first of two streets in the intersection. A list of available street names displays

when there are fewer than five available. Press the List screen button at any time to view the available street names.

2. Select a street from the list, or continue to spell the street name to further reduce the number of available street names.
3. After the first street has been selected, enter the second street name. The List button may again become available.
4. Select the second street from the list, or continue to spell the street name to further reduce the number of available street names.

After both streets have been selected, a map screen appears with the destination marked.

5. Press
6. Press the Guide screen button.
See "Getting Started on Your Route" in this section.

Freeway Entrance/Exit

The freeway entrance/exit destination entry method lets you select a destination by entering a freeway entrance or exit point.

FM1 100.3 MHz		10:26
EMERGENCY		
Current	943 E CAPITOL ST NE	
Position	WASHINGTON, DC	
	LAT. N38°53'23" LONG W76°59'35"	
<input type="text" value="Police Station"/>		
<input type="text" value="Hospital"/>		
<input type="text" value="Dealer"/>		

F (Freeway Ent (Entrance)/Exit): Press this button from the ENTER DESTINATION screen to access the FREEWAY ENT/EXIT screen.

To use this destination entry method:

1. Enter the freeway name. Use abbreviations, such as I - 75, rather than spelling out Interstate.
The system displays a list of freeways.
2. Select a freeway from the list, and select whether you want an entrance point or an exit point.

Select an exit/entrance point from the list or input the point by name. Sort the list by name or by distance.

After selecting a point from the list, a map screen appears with the destination marked.

3. Press .
4. Press the Guide screen button.
See “Getting Started on Your Route” in this section.

Phone Number

The phone number destination entry method lets you select a destination by entering a phone number. The phone number must be in the list of POIs that is contained on the map DVD for the system to retrieve the destination.

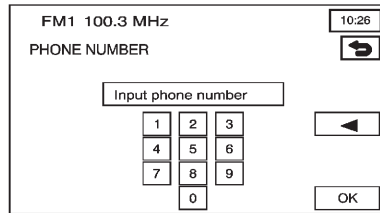

 **(Phone Number):** Press this button from the ENTER DESTINATION screen to access the PHONE NUMBER screen.

To use this destination entry method:

1. Input the phone number of a POI using the numeric keypad.

If the phone number can be found on the map DVD, a map screen appears with the destination marked. If the phone number is dependent on the area code, a list of POIs appear to select from. Once a POI is selected, a map screen appears with the destination marked.

2. Press .
3. Press the Guide screen button.
See “Getting Started on Your Route” in this section.

Coordinates

The coordinates destination entry method lets you select a destination by entering latitude and longitude coordinates.

🌐 (Coordinates): Press this button from the ENTER DESTINATION screen to access the COORDINATES screen.

To use this destination entry method:

1. Press N (North) or S (South) next to LAT (latitude) to enter the direction of the latitude coordinate.
2. Input the numeric portion of the latitude coordinate using the keypad.

3. Press E (East) or W (West) next to LONG (longitude) to enter the direction of the longitude coordinate.
4. Input the numeric portion of the longitude coordinate using the keypad.
5. Once both coordinates are entered, press OK.

A map screen appears with the destination marked.

If the coordinates are outside of the coverage area on the map, a message that there is no information on that location displays.

6. Press **⊙**.
7. Press the Guide screen button.
See “Getting Started on Your Route” in this section.

Preset Destination

The preset destination entry method lets you set a destination by choosing from one of five previously

stored destinations. Besides home, these are the only destinations available to set while the vehicle is moving.

To store, edit, or delete a preset destination, see “Destination and Waypoint” under *Stored Locations* on page 45.

To use this destination entry method:

1. Select a preset destination number button from the ENTER DESTINATION screen. The screen buttons are located on the bottom of the screen.

A map screen appears with the destination marked.

2. Press **⊙**.
3. Press the Guide screen button.
See “Getting Started on Your Route” in this section.

Home

This feature lets you plan a route to one previously stored destination that you have selected as a home. If a home destination is not stored, the home button is not available. Besides preset destinations one through five, this destination is the only other one that can be set by voice recognition while the vehicle is moving.

To store, edit, or delete a home location, see *Stored Locations on page 45*.

🏠 (Home): Press this button from the ENTER DESTINATION screen to set a home destination.

To use this destination entry method:

1. Press **🏠** from the ENTER DESTINATION screen.
2. The system then sets your preset home destination as the current destination. To store a preset home destination, see *Stored Locations on page 45*.

A map screen appears with the destination marked.

3. Press **⊙**.
4. Press the Guide screen button.
See “Getting Started on Your Route” in this section.

Getting Started on Your Route

Once a destination has been entered, choose from these options:

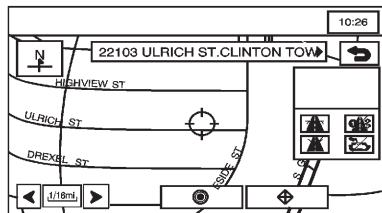

⊙ (Destination): Press to set the entered destination as it is, without further adjustment.

📍 (Waypoint): Press to enter this point as a waypoint along the route. This feature lets you enter up to five stops on the way to your destination. See “Destination and Waypoint” under *Stored Locations on page 45* for more information about adding and deleting waypoints.

Route Preference: Press to access the ROUTE PREFERENCES screen to adjust the route preferences. The current setting is displayed in the Route Preference section of the map screen. See “Route Preference” under *Route Options on page 58*.

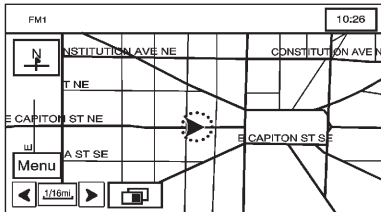

Once the route preferences have been set, the system displays the map screen.

After pressing , the following screen buttons become available.

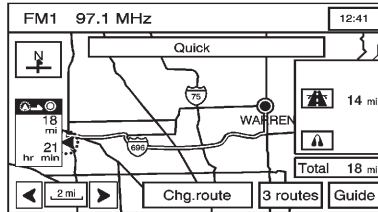

Chg. (Change) route: Press to go to the Route Options menu. See *Route Options* on page 58.

Guide: Press to start route and voice prompt guidance.

Three Routes:

This screen gives the option of selecting three different routes to get you to your destinations. To use the 3 routes option:

1. Press the 3 routes button on the map screen.

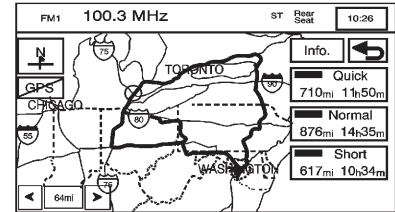

The system calculates up to

three different versions of your current route in three different choices: Quick, Normal, and Short. The routes are shown with distance to destination and estimated travel time, or select the Info screen button to access the INFO FOR 3 ROUTES screen. From this screen, you can view the following information:

FM1 91.5 MHz		10:26	
INFO FOR 3 ROUTES			
	Quick	Normal	Short
	11h 40m	14h 58m	10h 19m
	702miles	901miles	612miles
	0.0miles	0.2miles	131miles
	699miles	898miles	594miles
	0.0miles	0.0miles	0.0miles
	0.0miles	0.0miles	0.0miles

- **(Estimated Travel Time)** — Shows the route's estimated time of travel.

- **(Straight-Line Distance)** — Shows the route's straight-line distance to destination.
- **(Toll Road)** — Shows the distance traveled on toll roads.
- **(Freeway Travel)** — Shows the distance traveled on freeways.
- **(Ferry)** — Shows the distance traveled by ferry.
- **(Time Restricted Roads)** — Shows the distance traveled on time-restricted roads.

2. Press the Quick, Normal, or Short screen button.
A map screen appears with the destination marked.
3. Press the Guide screen button to start route and voice guidance.

Stored Locations

Press NAV. MENU to access the STORED LOCATIONS screen. From this screen, you can access the following options:

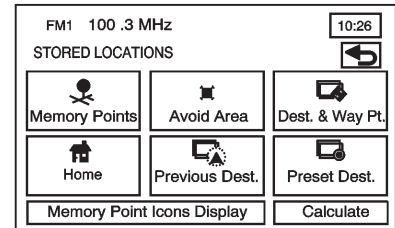

Memory Points

Memory Points: This feature can store memory points in these four categories: PERSONAL, BUSINESS, ENTERTAINMENT, and MARKED POINT. The category names can be changed.

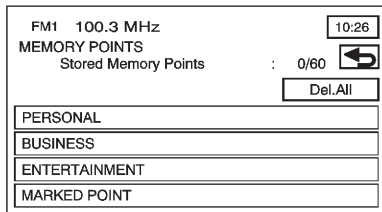

To store a point:

1. Press from the STORED LOCATIONS screen.
2. Select one of the folders/categories listed.
3. Press the Add screen button.
4. Select the desired method of entering a destination to enter the memory point. See *Enter Destination on page 32*. A map screen appears displaying the selected memory point location.

5. If available, press INFO to view the address information of the selected point.
6. Press OK to store the point as a memory point.

To edit the name of a stored point:

1. Press from the STORED LOCATIONS screen.
2. Select the folder/category that the memory point exists in.
3. Press the List screen button.
4. Select the memory point to edit. Use the sort feature to sort by distance, icon, name, or date as needed.
5. Press Name from the EDIT MEMORY POINT screen.
6. Use the backspace screen to delete the current name or use the alpha keypad to make changes.

Select the Show Name On screen button to have the name of the point appear on the map screen.

7. Press to store the change.

To change the icon associated with a memory point:

1. Press from the STORED LOCATIONS screen.
2. Select the folder/category that the memory point exists in.
3. Press the List screen button.
4. Select the memory point to edit. Use the sort feature to sort by distance, icon, name, or date as needed.
5. Press Icon from the EDIT MEMORY POINT screen.
6. Select the desired icon. There are two pages (52) icons, six icons that have sounds associated with them, and a No Icon button to select from.

Press the With Sound screen button, and the sound icons display. To hear the sound of the icon, press the Sound screen button next to each icon. If the sound icons are used, the associated sound is heard when the vehicle is approximately 200 m (650 ft) from the memory point.

Press the No Icon screen button to not have an icon associated with the point.

The new icon displays in the EDIT MEMORY POINT screen, next to the Icon screen button.

7. Press  to store the change.

To move the memory point from one folder/category to another:

1. Press  from the STORED LOCATIONS screen.
2. Select the folder/category that the memory point currently exists in.
3. Press the List screen button.

4. Select the memory point to edit. Use the sort feature to sort by distance, icon, name, or date as needed.
5. Press Category from the EDIT MEMORY POINT screen.
6. Press the new folder/category button you want to move the memory point to.

The system displays a message confirming the move.

To modify the position of the stored point:

1. Press  from the STORED LOCATIONS screen.
2. Select the folder/category that the memory point exists in.
3. Press the List screen button.
4. Select the memory point to edit. Use the sort feature to sort by distance, icon, name, or date as needed.
5. Press Position from the EDIT MEMORY POINT screen.

The system displays the map screen with the destination marked.

6. Press the map to move the position of the memory point.
7. Press OK when you have moved the memory point to the appropriate location.
8. The system returns to the EDIT MEMORY POINT screen and displays the new address, longitude, and latitude for the changed memory point.

To change the phone number of a memory point:

1. Press  from the STORED LOCATIONS screen.
2. Select the folder/category that the memory point exists in.
3. Press the List screen button.
4. Select the memory point to edit. Use the sort feature to sort by distance, icon, name, or date as needed.

5. Press Tel. (telephone) from the EDIT MEMORY POINT screen.
6. Use the numeric keypad to change the phone number.
7. Press OK to store the changed phone number.

To delete a memory point:

1. Press  from the STORED LOCATIONS screen.
2. Select the folder/category that the memory point exists in.
3. Press Delete.
4. Select the memory point to delete from the DELETE POINT screen. Use the sort feature to sort by distance, icon, name or date as needed.
5. The system displays the map screen with the position address and a pop-up confirmation message. Select Yes to delete the point; select No to return to the DELETE POINTS screen and not delete the point.

To delete all of the memory points in a folder/category:

1. Press  from the STORED LOCATIONS screen.
2. Select the desired folder/category.
3. Press Del. All.
4. The system displays a pop-up confirmation message. Press Yes to delete all the points in the folder/category; press No to cancel the operation.

To change the name of the folder/category:

1. Press  from the STORED LOCATIONS screen.
2. Select the desired folder/category.
3. Press Edit Category.
4. Use the alpha keypad to change the name of the folder/category.
5. Press OK to save the changes.

Avoid Area

 **(Avoid Area):** This feature lets you store an area to be avoided while planning a route. Up to 10 points can be stored.

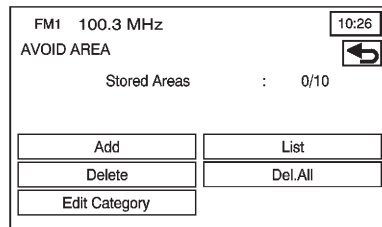

To store an avoid area point:

1. Press  from the STORED LOCATIONS screen.
2. Press Add from the AVOID AREA screen.
3. Select the desired method of entering a destination to enter the memory point. See *Enter*

Destination on page 32. A map screen appears displaying the selected memory point location.

- If desired, reduce or enlarge the area around the point you want to avoid by using the Reduce or Enlarge screen buttons.

It is recommended that when avoiding locations on freeways, you reduce the avoid area to the minimum scale. This produces an X on the map rather than a box. This ensures that the system knows you want to avoid the freeway itself, not necessarily the area around the freeway.

- Press OK to store the area.

To change the name of the point to be avoided:

- Press  from the STORED LOCATIONS screen.
- Press List from the AVOID AREA screen.
- Select the point to be changed.

- Press the Name screen button.
- Use the alpha keypad to add or to change the name.

Press the Show Name On screen button to have the name of the point appear on the map screen.

- Press OK to save the changes.

To change the position of the point to be avoided:

- Press  from the STORED LOCATIONS screen.
- Press List from the AVOID AREA screen.
- Select the point to be changed.
- Press Position.
- Press the map to move the location.
- If desired, reduce or enlarge the area around the point you want to avoid by using the Reduce or Enlarge screen buttons.
- Press OK to store the area.

To delete a point to be avoided:

- Press  from the STORED LOCATIONS screen.
- Press Delete from the AVOID AREA screen.
- Select the point to delete. Use the scrolling arrows as needed.
- The system displays the map screen with the name of the point and a pop-up confirmation message. Press Yes to have the point deleted; press No to cancel the function.

To delete all of the points to be avoided:

- Press  from the STORED LOCATIONS screen.
- Press Del. All from the AVOID AREA screen.
- The system displays a pop-up confirmation message. Press Yes to have all of the points deleted; press No to cancel the function.

Destination and Waypoint

 **Dest. & Way Pt. (Destination and Waypoint):** Waypoints are destinations that can be added to your route before reaching the final destination. Waypoints can be added before or after entering a final destination. Waypoints that were entered prior to setting a final destination, will delete if a final destination has not been entered. Up to five points can be stored as waypoints.

To add a waypoint:

1. Press  from the STORED LOCATIONS screen.
2. Press Add from the DEST. & WAY POINT screen.
3. Using the desired method of entering a destination, enter the way point. See *Enter Destination on page 32*.

A map screen appears with the way point marked.

4. Select  (Way Point) icon on the map screen to save the way point.
5. Repeat Steps 2 through 6 to add up to five way points to your route. After the first waypoint has been saved, the ADD WAY POINT screen appears and the waypoint is on the screen. The second through the fifth waypoint does not appear on the ADD WAY POINT screen until the ADD button, next to the corresponding waypoint row, is pressed. After the ADD button has been pressed, the system returns to the STORED LOCATIONS screen.

To change the order of the waypoints:

1. Press  from the STORED LOCATIONS screen.
2. Press List from the DEST. & WAY POINT screen.

3. From the CHANGE ORDER screen, select on the addresses, in the order you would like them to fall on the route. After selecting the address line, a number, indicating the order, appears next to the corresponding row.
4. Select OK to save the changes. The system returns to the STORED LOCATIONS screen.

To change the location of a waypoint:

1. Press  from the STORED LOCATIONS screen.
2. Press List from the DEST. & WAY POINT screen.
3. Press Chg. Loc. from the CHANGE ORDER screen.
4. From the CHANGE LOCATION screen, select the address of the location to change. A map screen displays with the destination marked.

5. Press on the map to move the location of the waypoint.
6. Press OK to save the changes. The system returns to the STORED LOCATIONS screen.

To delete a waypoint from the current route:

1. Press  from the STORED LOCATIONS screen.
2. Press Delete from the DEST. & WAY POINT screen.
3. Select the way point/destination to delete.
4. The system displays a pop-up confirmation message. Choose Yes to delete the way point; press No to cancel this operation.

To delete all of the waypoints on the route:

1. Press  from the STORED LOCATIONS screen.
2. Press Del. All from the DEST. & WAY POINT screen.

3. The system displays the map screen with a pop-up confirmation message. Choose Yes to delete all of the way points; press No to cancel this operation.

Home

 (**Home**): This feature lets you store, delete, and edit a home point destination.

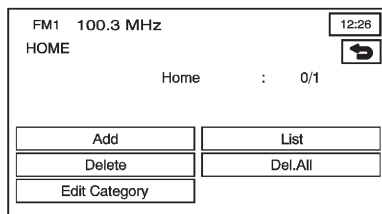

To store the home destination:

1. Press  from the STORED LOCATIONS screen.

2. Press Add.
3. Select a destination entry method from the SET HOME screen. See *Enter Destination on page 32*.
4. Set the destination and press OK.
5. Press OK on the map screen and the destination stores. The home icon now is highlighted on the ENTER DESTINATION screen.

To edit the home destination, do the following:

1. Press  from the STORED LOCATIONS screen.
2. Press List from the HOME screen to change the location.
3. Press the map to move the location of the point.
4. Press OK to save the change.

To delete the home point:

1. Press  from the STORED LOCATIONS screen.

2. Press Delete from the HOME screen.
3. The system displays the map screen with a pop-up confirmation message. Press Yes to delete the stored home position; press No to cancel the operation.

Previous Destination

 **Previous Dest. (Previous Destination):** The system automatically stores up to 100 points that have been previously entered. As new destinations are entered, the system automatically deletes the oldest destinations and adds the new entries. See *Enter Destination on page 32*.

To delete a specific destination from the previous destinations list:

1. Press  from the STORED LOCATIONS screen.
2. Press Delete.
3. Select a destination from the list.

4. The system displays the map screen with a pop-up confirmation message. Press Yes to delete the stored destination; press No to cancel the operation.

To delete all destinations from the previous destinations list:

1. Press  from the STORED LOCATIONS screen.
2. Press Del. All.
3. The system displays the map screen with a pop-up confirmation message. Press Yes to delete all of the stored destinations; press No to cancel the operation.

Preset Destination

 **Preset Dest. (Preset Destination):** This feature lets you store up to five preset destinations. These destinations are stored on the numbered buttons shown on the bottom of the ENTER DESTINATION screen.

To store a preset destination:

1. Press  from the STORED LOCATIONS screen.
2. Press Add to add a preset destination, then select the numbered preset button for the destination to appear as.
3. Select a destination entry method from the STORE PRESET DEST. screen. See *Enter Destination on page 32*.
4. Set the destination and press OK.
5. Press OK on the map screen and the destination stores. The preset destination number is now highlighted on the ENTER DESTINATION screen.

To edit the name of a preset destination:

1. Press  from the STORED LOCATIONS screen.
2. Press List.

3. Select the preset destination to edit.
4. Press Name and use the alpha keypad to edit or add the name.

Press the Show Name On screen button to have the name appear on the map screen.

5. Press OK to save the change.
The new name displays.

To change the position of a preset destination, do the following:

1. Press  from the STORED LOCATIONS screen.
2. Press List.
3. Select the preset destination to change.
4. Press Position from the EDIT PRESET DEST. screen. The system displays the map screen with the destination marked.
5. Press the map to move the position of the memory point.
6. Press OK to save the change.

To add or change the phone number of a preset destination:

1. Press  from the STORED LOCATIONS screen.
2. Press List.
3. Select the preset destination to change.
4. Press Tel. (telephone) and use the numeric keypad to enter or change the phone number.
5. Press OK to save the change.

To delete a preset destination:

1. Press  from the STORED LOCATIONS screen.
2. Press Delete.
3. Select the memory point to delete from the DELETE PRESET DEST. screen.
4. The system displays the map screen with the position address and a pop-up confirmation message. Press Yes to delete the point; press No to cancel the

operation and to return to the DELETE PRESET DEST. screen.

To delete all of the preset destinations:

1. Press  from the STORED LOCATIONS screen.
2. Press Del. All.
3. The system displays a pop-up confirmation message. Press Yes to delete all of the preset destinations; press No to cancel the operation.

Memory Point Icons Display:

Press this screen button to display memory point icons on the map. The button is highlighted when the memory point icons are being displayed on the map.

Calculate: Press this button to calculate your route. This button is available after a destination has been set.

Navigation Set Up

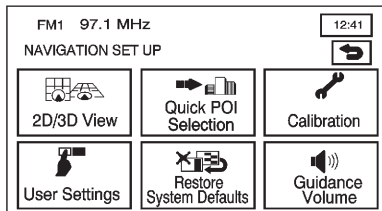

Select the MENU screen button to access NAV. MENU.

Navigation Set Up: Press this button from the NAV. MENU screen to access the NAVIGATION SET UP screen. Several system options are available for adjustment.

Two-Dimensional/ Three-Dimensional (2D/ 3D) View

2D/3D View: Press this button from the NAVIGATION SET UP screen. This feature lets you change the view of the map between a 2-dimensional and 3-dimensional view.

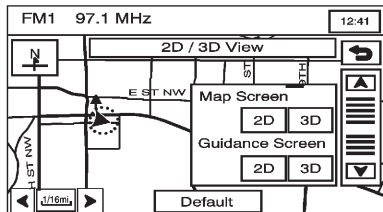

Map Screen 2D/3D: Changes the view of all map screens.

Guidance Screen 2D/3D: Changes the view of the map screen while driving during route guidance.

▲ / ▼ (Scroll Arrows): Press the arrows to tilt the view of the map screen.

Return: Press to save the changes.



Default: Press to cancel your changes and return to the default settings (2D and 3D).

Quick POI Selection

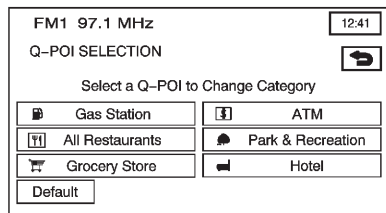
Quick POI Selection: This feature lets you select the POI categories you want available on the Quick POI (Q-POI) screen.



To replace the default POI categories on the Quick POI (Q-POI) screen:

1. Press   (Quick POI Selection) from the NAVIGATION SET UP menu. This screen displays the list of POI categories.
2. Select the POI category that you would like to change. The category to change displays with the list of categories to select from.

Press All Category List to display all categories and sub-categories.

3. Press a different POI category. The POI category icon to change is replaced with the new POI category icon at the top of the screen. This POI is now available on the Q-POI screen.

Quick POI

Once categories have been selected on the Q-POI SELECTION screen, the POI categories are now available on the Quick POI screen. From this screen you can select the POI icons that you would like to display on the map screen. You can either select a POI for a final destination or as a waypoint. The Quick POI screen is available when the scale is 1 km (½ mi) or less.



To use the QUICK POI screen, press the POI screen button from the map screen.

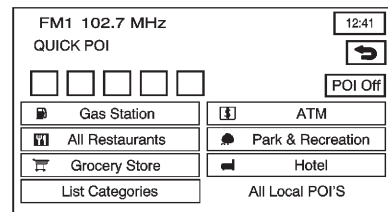

The POI categories that were selected on the Q-POI SELECTION screen display.

To have the POI icons appear on the map screen, select the POI category. The POI category icon displays at the top of the screen.

List Categories: Select to display more categories to select from.

All Local POIs

1. Press this screen button to select a POI as a destination. A list of all of the local POIs within a 8 km (5 mi) radius of your vehicle's current position will display. This list is generated from the POI categories that have been selected and appear at the top of the QUICK POI screen.

Use the Sort by Dist. (distance), Icon, Name, or Route screen buttons. Use the up and down scroll arrow screen buttons to scroll through the list.

2. Select the POI. The map screen displays with the scroll symbol around the selected POI. The

name and the POI information will also display on the map screen.

3. Press .
4. Press the Guide screen button. See "Getting Started on Your Route."

All Category List: This button appears once List Categories has been selected. Press to display a list of sub-categories.

Show: Press to display the map screen.

Delete: To delete a category:

- To delete the last added POI category, press Delete.
- To delete a specific POI category, select that POI category from the list.

POI Off: Press to delete all of the POI categories in the list.

Calibration

 **(Calibration):** Press this button from the NAVIGATION SET UP screen. This feature lets you recalibrate the navigation system.

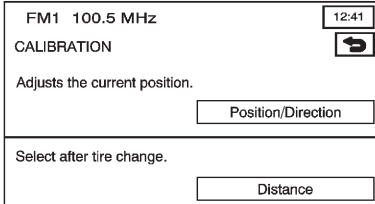

FM1 100.5 MHz	12:41
CALIBRATION	
Adjusts the current position.	Position/Direction

Select after tire change.	Distance

The vehicle's current position or the vehicle's speed signal can be adjusted on the map by using the CALIBRATION screen.

To adjust the vehicle's current position or the vehicle's speed signal:

1. Press the Position/Direction screen button.

The map screen displays with the vehicle's current position.

- To change the vehicle's position, press the map screen.

Use the zoom in/out function to view the direction of the desired area.

Pressing/holding and dragging on the map activates fast scrolling. Press once on the area where the current position mark should be moved.

- Press OK once the vehicle is in the current position.

If a route had already been set, the map screen displays, press Guide to change your route to the vehicle's new position.

Once the process of changing the vehicle's current position is complete, the map screen displays with rotate arrow screen buttons around the vehicle.

- To change the direction of your vehicle, press either arrow to turn the vehicle to the correct direction.
- Once the vehicle is facing the correct direction, select OK.

See *Problems with Route Guidance on page 72*.

If there are tire pressure differences or a spare tire is installed, the system automatically re-calibrates the system but it may take longer. To calibrate the vehicle speed signal, press the Distance screen button. See *Vehicle Positioning on page 71*.

User Settings

 **(User Settings):** Press this button from the NAVIGATION SET UP screen. This feature allows several route options to be turned on or off.

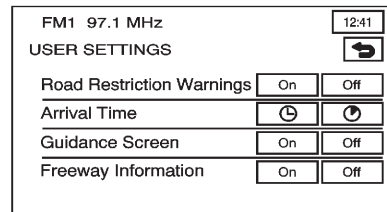

From this screen, adjust the following:

Road Restriction Warnings:

Instructs the system to notify you when the current route has traffic restrictions.

Arrival Time ☰ (Time of Arrival):

Displays the estimated time of arrival to the destination.

Arrival Time ☱ (Time to Destination): Displays the amount of drive time estimated to arrive at the destination.

58 Infotainment System

Guidance Screen: Turns the guidance screen on and off.

Freeway Information: Displays freeway exit information. This is only available on freeways during route guidance.

Restore System Defaults

 **(Restore System Defaults):**

Select this feature from the NAVIGATION SET UP screen to change all adjustable system settings to factory defaults.

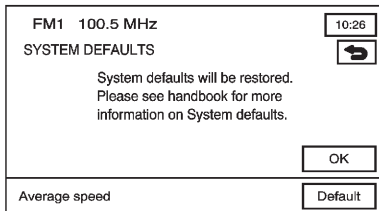

OK: Press to restore the system defaults.

Average Speed Default: Press to set the average speed to default. The system monitors the speed on different roads and updates the vehicle's average speed. This average speed is used to calculate the time it takes to reach the destination when a route is set.

Guidance Volume

 **(Guidance Volume):** Press to adjust the volume of voice guidance prompts. Press Off to turn voice guidance prompts off.

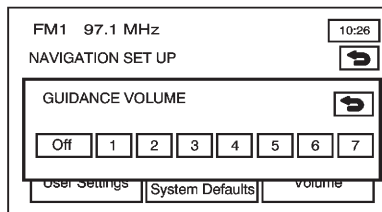

Route Options

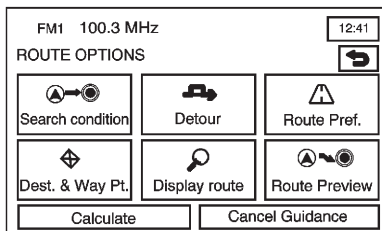

Select Route Options from the NAV. MENU screen to access the ROUTE OPTIONS screen. This menu has many features to customize route guidance. A route must first be set to use these features. See *Enter Destination on page 32* for more information on entering a destination.

Search Condition

 **Search Condition:** Press to access the SEARCH CONDITION screen.

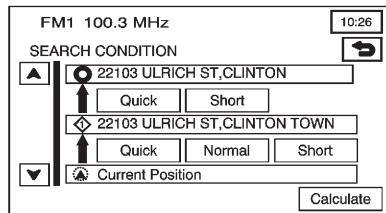

The search condition screen lets you view your current destination and to change the planning methods between each destination. Each distance between waypoints and final destination can have an individual setting.

 **(Scroll Arrows):** Use the arrows to scroll through each route.

Quick/ Normal/Short: Select one of the route preference options to change the planning method.

Calculate: After selecting the new methods, press Calculate to plan the route with the changes. The map screen displays.

Detour

 **(Detour):** Select a detour if there is construction work, or traffic delays that prevent the original route from being used.

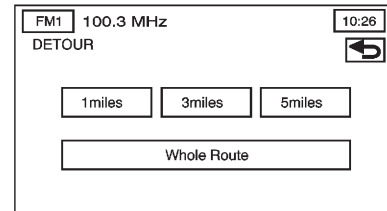

From this screen, you can select a 1 mile, 3 mile, or 5 mile detour or select to detour the whole route. After selecting the detour, the system calculates the alternate route and the new route displays on the map screen.

Route Preferences

 **Route Pref. (Route Preferences):** You can select to have certain types of roads/ferries included in your route. See “Getting Started on Your Route” under *Enter Destination on page 32*.

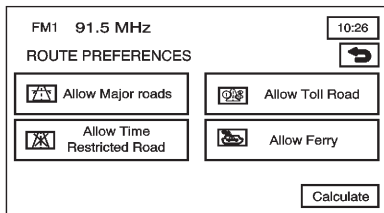

The following route preferences can be selected on or off:

Allow Major Roads: Press to use expressways when calculating a route. If there is no way to reach your destination without using major roads, the system automatically includes major roads.

Allow Time Restricted Road: Press to use time restricted roads when calculating a route. These are roads that may be closed during the winter season.

Allow Toll Road: Press to use toll roads or pay roads when calculating a route.

Allow Ferry: Press to use ferries when calculating a route.

Calculate: Press to update the changes in the current route. The map screen displays.

If any of these features are turned off, the button is dark and there is a red slash through the icon on the map screen.

Once the route preferences have been set, select the back button to return to the previous screen.

Destination and Waypoint

Dest. & Way Pt. (Destination and Waypoint): Press to edit the selected destination and waypoints using this screen. See “Destination and Way Point” under *Stored Locations on page 45* for information on storing destinations and waypoints.

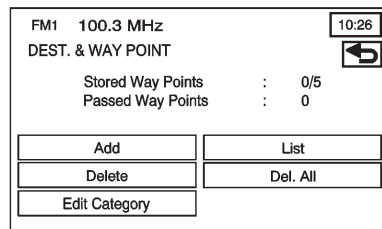

Up to five waypoints and one destination can be entered:

Add: Press to access the Store Dest. & Waypoint screen. A waypoint can be added or the destination can be changed.

List: Press to change the order of the stops in the route and to change the location of the stops.

Delete/Del. All: Press to delete waypoints on the route or delete the entire route.

Display route

Ⓞ (Display Route): Press this button from the ROUTE OPTIONS menu to view the entire route. The start point and destination, the time it takes to reach the destination, and distance, including the distance that is routed on each road type will display.

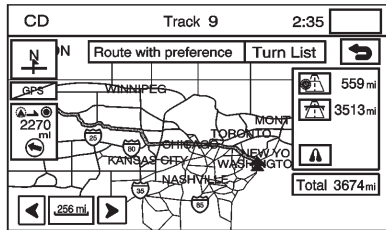

Turn List: Press to edit the route. A list of every turn on the route displays. With the turn list displayed, you can select to avoid streets/turns on the route.

Avoid: To avoid a street, press the Avoid screen button next to the turn. To cancel the avoided turn, press Avoid again to deselect it.

Reroute: After selections have been made, press to replan the route.

Delete: Press to cancel an avoided turn after the route has been replanned. A list of all the avoided turns displays. Select the street that you want to add back to the route. A confirmation window displays. Press Yes to have the avoided street added back to the route. The Turn List screen displays.

Del. All (Delete All): To cancel all of the avoided turns after the route has been replanned, press the Delete screen button. A list of all of the avoided turns displays. Press Del. All. A confirmation window displays. Press Yes to have all of the avoided streets added back to the route. The Turn List screen displays.

Route Preview

ⓄⓄ (Route Preview): Press this button from the ROUTE OPTIONS menu to preview the entire route in either direction and to edit the route.

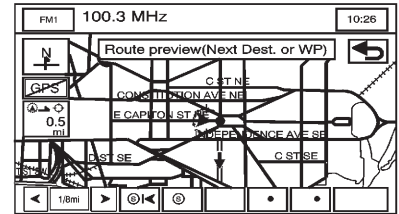

Use the screen buttons at the bottom of the navigation screen to move through the route.

ⓄⓂ (Skip to Start Point): Press to skip backward to the start point, the previous waypoint, or the previous available POI, depending on the mode selected.

62 Infotainment System

Ⓢ ◀ (Scroll to Start Point): Press to start a smooth scroll of the route backwards to the start point, previous waypoint, or the previous available POI, depending on the mode selected. Press again to increase the scroll speed.

⏸ (Pause): Press to pause the smooth scroll. Press either scroll button (Ⓢ ◀▶ Ⓢ) to restart the scroll.

▶ Ⓢ (Scroll to Destination): Press to start a smooth scroll of the route toward the destination, next waypoint or next available POI, depending on the mode selected. Press again to increase the scroll speed.

▶ Ⓢ (Skip to Destination): Press to skip forward to the destination, next waypoint or next available POI, depending on the mode selected.

Edit: Press to change the way the skip/scroll function operates. Press to have the skip/scroll go to the start point/destination or to the next available POI or waypoint.

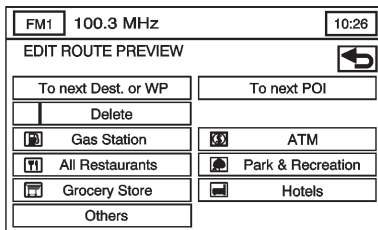

To next Dest. (Destination) or WP (Waypoint): Press to have the skip/scroll functions skip/scroll to the next destination or waypoint.

To next POI: To select this option, a POI category must be selected. Press this button to have the skip/scroll functions skip/scroll to the next available POI for the category.

To change the POI category, press the corresponding screen button next to the category. Press the Delete screen button to have no POIs appear on the map. The default POIs are the same as those in the Quick POI group listing.

Calculate: Press this screen button to calculate the route with the changes.

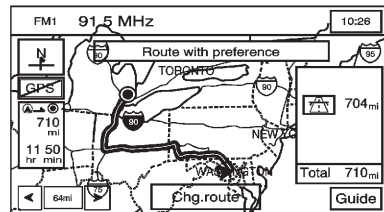

Once the route has been calculated, this screen displays. From this map screen, Press Guide to begin route

guidance or press Chg. route to return to the ROUTE OPTIONS screen.

Cancel Guidance: Press this screen button to cancel the current route.

Head-Up Display (HUD)

When a route is planned the Head-Up Display (HUD) will display information when the vehicle is approaching a turn. This information displays when the vehicle is 0.8 km (0.5 mi) away from a turn in residential areas and 2.0 km or 1.24 mi away from a turn on freeways.



- A. Directional Arrow — Displays the direction of the next turn.
- B. Distance Bar — This will decrease as the vehicle approaches the turn.
- C. Street Name Line — Displays the name of the street that you will be turning on.
- D. Mile/Kilometer Scale — Indicates the scale of the distance bar. The scale is 0.80 km (0.5 mi) in residential areas and 2.0 km or 1.24 mi on freeways. This value changes as you approach the turn.

After completing a turn, the HUD displays the name and distance of the next street you are turning on for 10 seconds.

When HUD is displaying the turn-by-turn guidance information, the vehicle's shift lever gear does not display in the HUD. The gear displays on the Driver Information Center (DIC) screen. Once the destination has been reached or guidance is cancelled, the HUD displays the gear information again. See "Head-Up Display (HUD)" in the owner manual.

Maps

This section includes basic information needed for the map database.

The maps are stored on a DVD-ROM. The 48 contiguous United States and portions of Canada are contained on two discs. To minimize the necessity of changing the discs, both map discs cover US6, US7, and Canada.

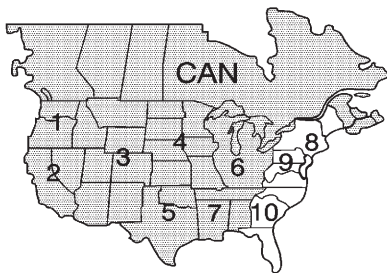

West

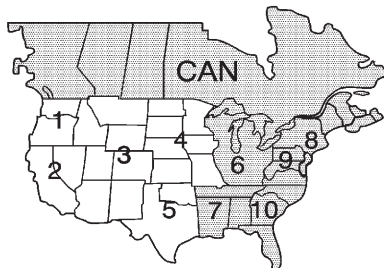



East

Installing the DVD Map Disc

Your dealer may have installed the map DVD. If the map DVD was not installed, do the following to load it:

Read the following steps completely before operating this feature.

1. Turn the ignition on.
2. Press the  (Open/Close Faceplate) button and the faceplate opens.

3. Load the map DVD into the DVD slot by inserting it partway. The system pulls it in.
4. Wait until the DVD is loaded properly and then press the  button to close the faceplate.

Once the map DVD is inserted correctly, the system displays the Caution screen.

Agree: Press to proceed to the navigation system.

The map appears showing your current vehicle position.

DVD Map Disc Messages

If an error displays and/or the map disc comes out, it could be for one of the following reasons:



- If the map disc was installed into the CD slot. See “Installing the DVD Map Disc” previously.
- It is very hot, when the temperature returns to normal, the map disc should play.

- You are driving on a very rough road. When the road becomes smoother, the map disc should play.
- The map disc is dirty, scratched, wet, or upside down.

If any error occurs repeatedly or if an error cannot be corrected, contact your dealer.

Ejecting the DVD Map Disc

When the DVD map disc is not loaded, you are not able to use the navigation portion of the system.

1. Turn the ignition on.
2. Press the  (Open/Close Faceplate) button and the faceplate opens.
3. Press  DVD, located next to the bottom slot. The disc ejects.
4. Wait until the DVD is ejected properly and then press  (Open/Close Faceplate) to close the faceplate.

Handling the DVD Map Disc

When handling the DVD map disc, be careful of the following:

- Handle the disc very carefully to avoid contamination or flaws. Signals may not read out properly if the disc gets contaminated or flawed.
- If the disc gets soiled, use a soft cloth to gently wipe it out from the center of the disc to the outside. Do not use photographic record cleaner, solvents, or other cleaners.
- Do not use the disc to rest on while writing or drawing using any writing utensil or attach a seal to any of the sides or the disc.
- Do not keep the disc in direct sunlight, high temperatures, or humidity.
- After using the disc, place it back into the original case.

Setting the Search Area

See *Enter Destination on page 32* for information on changing the search area.

Map Adjustments

The system lets you adjust the scale of view on the map. Also, as you drive, the map scrolls automatically based on the direction you are traveling.

Map Scales

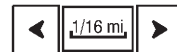

To view a larger or smaller scale of the map, touch the map scale arrows.

Change the level of map detail by either zooming in or zooming out using the arrow screen buttons or by touching the scale on the bar.

The system adjusts the map accordingly. The scale of a map can range from 0.05 km (0.31 mi) to 256 km (159 mi).

Scrolling the Map



Press anywhere on the map screen twice and the scroll symbol appears. Use this feature to scroll across the map.

If scrolling while the vehicle is in P (Park), the system scrolls initially at a slower rate. Continue to press the map screen to increase the scrolling speed.

If scrolling while the vehicle is in motion, the system will scroll to that location and stop.

If you have used the scroll feature to scroll the map and if the vehicle icon becomes lost, press NAV to return to the current vehicle location on the map.

Use the scroll feature on the map to set a destination. See "Map" under *Enter Destination on page 32*.

Navigation Symbols

The following symbols are the most common symbols that appear on a map screen.



The vehicle is shown as this symbol. It shows the position and direction the vehicle is moving on the map.



This symbol marks the final destination of the planned route.



This symbol appears on the map for a planned waypoint.

The waypoint symbol is numbered from 1 through 5 depending on how many waypoints have been set.



This symbol indicates the distance to the final destination. It only appears when the time symbol does not appear.



This symbol indicates the distance and the estimated time remaining to the final destination or arrival time, depending on the option selected.

See *Navigation Set Up* on page 54.



This symbol shows the straight-line distance to the final destination.

This symbol may appear before starting to drive on the route or if on a road where navigation guidance cannot be given. See *Database Coverage Explanations* on page 73.



This symbol indicates the map with North Up (North Up mode).

While in North Up mode, North is always at the top of the map screen regardless of which direction the vehicle is traveling. Press this screen symbol to switch between North Up and Heading Up modes.



This Heading Up mode symbol indicates the map with the vehicle travel direction up.

The shaded triangle indicates the North direction. While in Heading Up mode, the direction the vehicle is traveling is always at the top of the map screen. The vehicle icon is always headed in the direction the vehicle is traveling. Press this screen symbol to switch between Heading Up and North Up modes.



This symbol appears in the upper right corner when the vehicle is not receiving a Global Positioning System (GPS) satellite signal.

See *Global Positioning System (GPS)* on page 71.



When a name is too long to be displayed, an arrow symbol appears. Press the arrow screen buttons to scroll through the entire name.



This symbol indicates the position of the next guidance maneuver.



Press this symbol to set the current route as the destination.



Press this symbol to enter a waypoint along the current route.



Press this symbol to store the location on the screen as a memory point.

Map Appearance



Select this symbol from the map screen to display the map appearance options.

Select from one of the following six options to allow different views and information of the map screen. Availability of these options depends on the current route. The current view is highlighted.



Select the single map mode to display more of the map with a window that gives the direction and distance to the upcoming maneuver.



Press the dual view symbol to display two map screens that allow different scale levels and heading direction for each window.

Press anywhere inside the right screen and the EDIT RIGHT SCREEN displays. Change the scale level, 2D and 3D view, and to

turn the POIs on and off. To change the heading direction, touch the North Up or Heading Up symbol.



Press the turn list symbol to display the next three upcoming maneuvers on the map screen when on route guidance.

Directional arrows, street name, and distance to the next turn display. As you approach the next turn, the system automatically displays a zoomed-in view of the upcoming maneuver.



Press the arrow guidance symbol to display the next turn on the map screen when on route guidance.

Directional arrows, street name, and distance to the next turn display. When approaching the next turn, the system automatically displays a zoomed-in view of the upcoming maneuver.



Press this symbol to display only the next maneuver along with a small map of the maneuver.

When approaching the next maneuver, the system displays a guidance window of the maneuver. This option can be turned off by the USER SETTINGS screen.



Press the highway guidance symbol to display highway guidance on the map screen.

The upcoming exit number, distance to the exit, available POIs at the exit, and a window with the direction and distance to the next maneuver display.

Use the arrows to scroll through the list. To view the available POIs for an exit, select the exit, then select the Map screen button.

The system displays highway guidance any time you have a planned route on a highway or freeway. To turn this feature off, see “User Settings” under *Navigation Set Up* on page 54.

Auto Reroute

When a destination has been set but the vehicle is off of the planned route, the system automatically plans a new route. The new route is highlighted on the screen.

Traveling Across Regions

When driving through regions, the map screen updates to display the current location. To plan a destination in a different region, the region must be changed for the map DVD to access the correct information.

1. Change the selected region in the search area when closer to the destination. See *Enter Destination* on page 32.
2. Change the selected region in the search area when entering the destination and route settings. See *Enter Destination* on page 32.

For example, if you were traveling from Michigan to Florida, make sure that Florida is

included on the selected region. Enter a destination in Florida under the ENTER DESTINATION menu.

Navigation Menu

Press NAV to access the map screen. Press the MENU touch-screen button on the map screen.

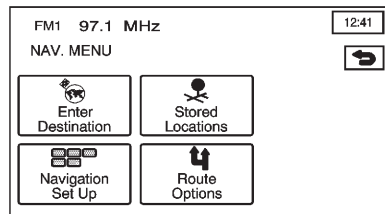

All of the navigation system features can be accessed from this screen.

Global Positioning System (GPS)

The navigation system determines the position of your vehicle by using satellite signals, various vehicle signals, and map data.

At times, other interferences such as the satellite condition, road configuration, the condition of the vehicle and/or other circumstances can interfere with the navigation system's ability to determine the accurate position of the vehicle.

The GPS shows the current position of your vehicle using signals sent by the GPS Satellites of the United States Department of Defense. When your vehicle is not receiving signals from the satellites, a symbol appears on the map screen. Refer to *Navigation Symbols on page 66*.

This system may not be available or interferences may occur if any of the following are true:

- Signals are obstructed by tall buildings, trees, large trucks, or a tunnel.
- Objects are located on the rear shelf of the vehicle.
- Satellites are being repaired or improved.
- After-market glass tinting has been applied to the vehicle's rear windshield.

Notice: Do not apply after-market glass tinting to the vehicle's windows. Glass tinting interferes with the system's ability to receive GPS signals and causes the system to malfunction. The window might have to be replaced to correct the problem. This would not be covered by the warranty.

If the GPS is not functioning properly, see *Problems with Route Guidance on page 72* and *If the System Needs Service on page 73*.

Vehicle Positioning

At times, the position of the vehicle on the map may be inaccurate due to one or more of the following reasons:

- The road system has changed.
- The vehicle is driving on slippery road surfaces such as in sand, gravel and/or snow.
- The vehicle is traveling on winding roads.
- The vehicle is on a long straight road.
- The vehicle is approaching a tall building or a large vehicle.
- The surface streets run parallel to a freeway.
- The vehicle has just been transferred by a vehicle carrier or a ferry.

- The current position calibration is set incorrectly.
- The vehicle is traveling at high speed.
- The vehicle changes directions more than once, or when the vehicle is turning on a turn table in a parking lot.
- The vehicle is entering and/or exiting a parking lot, garage or a lot with a roof.
- The GPS signal is not received.
- A roof carrier is installed on your vehicle.
- The vehicle is equipped with tire chains.
- The tires are replaced.
- The tire pressure for your tires is incorrect.
- The tires are worn.
- The first time the map DVD is inserted.
- The battery is disconnected for several days.

- The vehicle is driving in heavy traffic where driving is at low speeds, and the vehicle is stopped and started repeatedly.

If any of those problems occur, the system may need to be re-calibrated. This could be due to tire pressure differences, or if a spare tire is installed. To calibrate the system, see *Navigation Set Up on page 54*.

Problems with Route Guidance

Inappropriate route guidance can occur under one or more of the following conditions:

- A turn was made that was not on the route.
 - Route guidance may not be available when using automatic rerouting for the next right or left turn.
 - The route may not be changed when using automatic rerouting.
- There is no route guidance when turning at an intersection.
 - Plural names of places may be announced occasionally.
 - It may take a long time to operate automatic rerouting during high-speed driving.
 - Automatic rerouting may display a route returning to the set waypoint if you are heading for a destination without passing through a set waypoint.
 - The route prohibits the entry of a vehicle due to a regulation by time or season or any other regulation which may be given.
 - Some routes may not be searched.
 - The route to the destination may not be shown if there are new roads, if roads have recently changed or if certain roads are not listed on the map DVD. See *Ordering Map DVDs on page 73*.

To recalibrate the vehicle's position on the map, see *Navigation Set Up* on page 54.

If the System Needs Service

If your system needs service and you have followed the steps listed here and still are experiencing problems, see your dealer for assistance.

Ordering Map DVDs

The map DVD in the vehicle is the most up-to-date information available when your vehicle was produced. The map DVD is updated periodically, provided that the map information has changed.

For questions about the operation of the navigation system or the update process, contact the GM Nav Disc Center toll-free phone number, 1-877-NAV-DISC (1-877-628-3472) or go to the center's website, www.gmnavdisc.com. To update or replace a disc, call the GM Nav Disc

Center or order a new disc online. Have the Vehicle Identification Number (VIN) available when ordering. This ensures that you receive the correct and most up-to-date DVD map disc for your vehicle. See "Vehicle Identification Number (VIN)" in the owner manual.

After receiving the updated disc, replace the old disc in the navigation system. See "Installing the DVD Map Disc" under *Maps* on page 63. Dispose of the old disc to avoid confusion about which disc is the most current.

Database Coverage Explanations

Coverage area depends upon the map detail available. Some areas have greater map detail than others. The navigation system works only as well as the information provided on the map disc. See *Ordering Map DVDs* on page 73 on how to obtain updated map information.

Voice Recognition

The navigation system's voice recognition allows for hands-free operation of navigation and audio system features. Voice recognition can be used when the ignition is on or in ACC/ACCESSORY or when Retained Accessory Power (RAP) is active.

This feature only works if the map DVD is inserted. If you try to use voice recognition without the map DVD inserted, the system displays "Please insert the navigation map DVD to use the voice recognition feature." See "Installing the DVD Map Disc" under *Maps* on page 63.

The system may not hear you or may hear the incorrect word with the windows open or the convertible top down due to background noise.

To use voice recognition:



1. Press and hold  until a beep is heard. The audio system mutes.
This button is located on the left side of the navigation system faceplate.
2. Clearly state one of the commands listed on the following pages. For example, say “FM1.”
3. The system states the command being implemented. For example, the system says “FM1 Radio” and the audio system changes to the FM1 source.

You may end voice recognition by not speaking any commands. After about five seconds of silence, the system automatically cancels voice recognition.

At times, the system may not understand a spoken command. If this happens, try again. If a spoken command is not available, the system provides feedback based on availability.

While using voice recognition, make sure to keep interior noise levels to a minimum. Otherwise, the system might not recognize voice commands.

The system only recognizes commands spoken in English.

Voice Recognition Commands

The following list shows all of the voice commands available for the navigation system with a brief description of each. Any words shown in square brackets are optional. If there are words shown in parentheses, choose one of the

options. To use the voice commands, refer to the instructions listed previously.

Help Commands

These commands are universal and enable you to use the help prompts available from the system.

Command Help/List: Enables the system to provide the available commands for the navigation radio.

Cancel: Cancels the voice recognition function.

Radio Commands

Radio: Changes the audio system to the next radio audio source.

AM: Changes the audio system to the AM audio source.

FM1: Changes the audio system to the FM1 audio source.

FM2: Changes the audio system to the FM2 audio source.

XM1: Changes the audio system to the XM1 audio source.

XM2: Changes the audio system to the XM2 audio source.

Power On, Audio On: Turns the system's power on.

Power Off, Audio Off: Turns the system's power off.

Seek Up: The selected audio source seeks to the next strongest station.

Seek Down: The selected audio source seeks down to the next strongest station.

CD Player Commands

Track Up: The CD player skips to the next track.

Previous Track: The CD player goes to the previous track.

Track Down: The CD player goes to the beginning of the track or goes to the previous track if the track has elapsed nine seconds.

Screen Commands

Screen Day Mode, Day Mode

On: Adjusts the system's screen setting to the day mode.

Screen Night Mode, Night Mode

On: Adjusts the system's screen setting to the night mode.

Screen Auto Mode, Auto Mode

On: Adjusts the system's screen setting to auto mode.

Screen Off: Turns the system's screen display off.

Position Commands

Current Position, Current Location, Show Current Position, Show Current Location: These commands will display the vehicle's current location on the map screen.

Map: The system displays the map screen.

Map Commands

Zoom In: The system zooms in when on the map screen.

Zoom In Maximum: The system zooms in to the minimum available map scale when on the map screen.

Zoom Out: The system zooms out when on the map screen.

Zoom Out Maximum: The system zooms out to the maximum available map scale when on the map screen.

Heading Up, Change to Heading Up: The system displays the Vehicle Up heading when on the map screen.

North Up, Change to North Up: The system displays the North Up heading when on the map screen.

Map Direction, Change Map Direction: The system changes the vehicle's direction from North up to heading up or heading up to North up on the map screen.

Mark, Mark This Point: The system marks the location as a memory point while on the map screen.

Right Map Zoom In: The system zooms in on the right map when in dual map mode.

Right Map Zoom In (Maximum/Minimum Scale): The system zooms in to the minimum available map scale on the right map when in dual map mode.

Right Map Zoom Out: The system zooms out on the right map when in dual map mode.

Right Map Zoom Out (Maximum/Maximum Scale): The system zooms out to the maximum available map scale on the right map when in dual map mode.

Right Map [Change to] / [Show] North Up [Mode]: The system displays the North Up heading on the right map when in dual map mode.

Right Map [Change to] / [Show] Heading Up [Mode]: The system displays the Vehicle Up heading on the right map when on the map screen and in dual map mode.

Right Map [Change Map]

Direction: The system changes from North Up to Heading Up or from Heading Up to North Up.

[Show/Change to] Dual Map

Mode: The system changes the map display to dual map mode.

[Show/Change to] Single Map

Mode: The system changes the map display to single map mode.

[Change to] 3D Map [Mode]: The system changes the map display to the 3-dimensional map.

[Change to] 2D Map [Mode]: The system changes the map display to the 2-dimensional map.

Destination Commands

Home, Go Home: The system enters the Home destination as a waypoint or final destination, if a home destination has been stored.

Go to Starting Point, Previous Starting Point: The system enters the last available starting point as a waypoint or final destination.

[Go to] Previous Destination: The system enters the last available destination as a waypoint or final destination, if one is available.

[Go to] Preset Destination

[Number] (number): The system goes to the preset destination number. This preset destination can be chosen as a waypoint or a destination. There must be a location stored in the preset destination number that is chosen. For example, first store a location in Preset Destination 3. Say "Go to Preset Destination 3." The system goes to Preset Destination 3 and prompt you to choose it as a waypoint or destination.

Add [to] Waypoint: The system adds the current marked point as a waypoint. This command is used after the following commands have been used: Home, Go to Starting Point, Go to Previous Destination.

Enter Destination: The system adds the current marked point as the final destination. This command

is used after the following commands have been used: Home, Go to Starting Point, Go to Previous Destination.

Guidance Commands

Repeat Guidance, Repeat Voice:

The system repeats the last available voice prompt guidance command if a destination has been set.

Louder: The system increases the volume of the navigation voice prompts.

Softer: The system decreases the volume of the navigation voice prompts.

Voice Guidance Off: The system turns off the navigation voice prompts if a destination has been set.

Voice Guidance On: The system turns on the navigation voice prompts.

[Change to] Arrow (Guide/Guidance): The system changes to Arrow Guidance screen view in the Guidance Menu if a destination has been set.

[Change to] Turn List (Guide/Guidance): The system changes to Turn List Guidance screen view in the Guidance Menu if a destination has been set.

[Change to] Freeway (Guide/Guidance): The system changes to Freeway Guidance screen view in the Guidance Menu if a destination has been set. This command is only available if you are on a freeway.

[Change to] Intersection (Guide/Guidance): The system changes to Intersection Guidance screen view in the Guidance Menu if a destination has been set. This command is only available when the next turn is less than 0.80 km (0.5 mi) away for city streets and 2 km (1.24 mi) away for freeways.

Entire Route, Entire Route Map, Route Overview: The system displays the entire route if a destination has been set.

Reroute: The system generates an alternate route to a set destination while on a planned route.

Detour, Detour Entire Route: The system activates the detour feature when driving a planned route.

Next Waypoint Map: The system displays the map view of the next waypoint location if one has been set.

(First/Second/Third/Fourth/Fifth) Waypoint Map: The system displays the map view of the named waypoint location if it has been set.

Destination Map: The system displays the map view of the final destination location if one has been set.

Yes: Confirms system talkback.

No: Cancels a command.

(Delete/Cancel) Destination: The system cancels the current destination.

(Delete/Cancel) All Waypoints and Destination: The system cancels all currently set waypoints and the final destination.

Quick: The system selects the Quick route when a destination has been set.

Normal: The system selects the Normal route when a destination has been set.

Short: The system selects the Short route when a destination has been set.

Point of Interest (POI) Commands

The following commands cause the system to display icons if they are available on the map screen when the map scale is set to 1.0 km (0.6 mi) or less.

Automobile Commands

- Auto Service and Maintenance, Auto Service, Maintenance

- Automobile Club, Triple A
- Car Park
- Car Wash
- Gas Station, Gas
- Other Automotive
- Parking
- Parking Garage
- Parking Lot
- Rental Car Agency

Entertainment Locations

- Amusement Park
- Botanical garden
- Campground
- Casino
- Cinema
- Golf Course
- Horse Racing
- Marina
- Museum
- National and State Parks

- Park and Recreation, Parks and Recreation
- Performing Arts
- Ski Resort, Skiing
- Speedway
- Sport Complex, Stadium
- Tourist Attraction
- Video Rental
- Winery
- Zoological garden

Financial and Government Offices

- ATM
- Bank
- Business Facility
- City Hall
- Civic Center, Community Center
- Convention Center, Exhibition Center
- Court House
- Government Offices

- Higher Education, University, College
- Hospital
- Library
- Other Financial Services
- Police Station
- Post Office
- School
- City Center

Personal Services

- Beauty and Barber Shops
- Dry Cleaning
- Health and Fitness Club

Restaurant Locations

- American Restaurant, American Food
- Chinese Restaurant, Chinese Food
- Coffee House
- Continental Restaurant, Continental Food
- French Restaurant, French Food

- Ice Cream Parlor
- Italian Restaurant, Italian Food
- Japanese Restaurant, Japanese Food
- Mexican Restaurant, Mexican Food
- Other Restaurant, Other Food
- Restaurant, I'm Hungry
- Seafood Restaurant, Seafood
- Show Restaurant
- Thai Restaurant, Thai Food

Shopping Locations

- Convenience Store
- Department Store
- Grocery Store
- Home and Garden
- Other Retail Store
- Pharmacy
- Shopping, Shopping Mall
- Specialty Food Store

Transportation

- Airport
- Bus Station
- Ferry Terminal
- Historical Monument
- Hotel
- Park and Ride
- Rest Area, Rest Stop
- Tourist Information
- Train Station

POI Off: The system turns off POIs so they do not appear on the map screen.

Trademarks and License Agreements

Radio Frequency Statement

This device complies with part 15 of the FCC Rules. Operation is subject to the following two conditions: (1) This device may not cause harmful interference, and (2) this device must accept any interference received, including interference that may cause undesired operation.

FCC Warning

Changes or modifications not expressly approved by the party responsible for compliance could void the user's authority to operate the equipment.

This Category II radio communication device complies with Industry Canada Standards RSS-GEN/210/220/310.

Operation is subject to the following two conditions: (1) this device may not cause interference, and (2) this device must accept any

interference, including interference that may cause undesired operation of the device.

Ce dispositif de radio communication de catégorie II respecte la norme CNR-310 d'Industrie Canada.

L'utilisation de ce dispositif est autorisée seulement aux deux conditions suivantes: (1) il ne doit pas produire de brouillage, et (2) l'utilisateur du dispositif doit être prêt à accepter tout brouillage radioélectrique reçu, même si ce brouillage est susceptible de compromettre le fonctionnement du dispositif.



Manufactured under license under U.S. Patent #'s: 5,451,942; 5,956,674; 5,974,380; 5,978,762;

6,487,535 & other U.S. and worldwide patents issued & pending. DTS and the Symbol are registered trademarks and DTS Digital Surround and the DTS logos are trademarks of DTS Inc. All Rights Reserved.



Manufactured under license from Dolby Laboratories. Dolby and the double-D symbol are trademarks of Dolby Laboratories.



"Made for iPod" means that an electronic accessory has been designed to connect specifically to

iPod and has been certified by the developer to meet Apple performance standards.

iPod is a trademark of Apple Computer, Inc., registered in the U.S. and other countries.

A

Address 33
 Alpha-Numeric Keypad 31
 AM-FM Radio 12
 Audio Adjust Screen 13
 Audio Players 21
 CD 21
 Auto Reroute 70
 Auxiliary
 Devices 30
 Avoid Area 48

C

Calibration 56
 Canadian Vehicle Owners 4
 Canceling Guidance 10
 CD Errors 26
 CD Player 21
 Cleaning the Display 11
 Connecting a USB Storage
 Device or iPod® 26
 Coordinates 41

D

Database Coverage
 Explanations 73
 Deleting Personal Information 6
 Destination and Waypoint ... 50, 60
 Detour 59
 Devices
 Auxiliary 30
 Display route 61
 DVD Map Disc Messages 64

E

Ejecting the DVD Map Disc 65
 Emergency 38
 Enter Destination 32

F

Finding a Station 15
 Freeway Entrance/Exit 40

G

Getting Started on Your Route ... 43
 Global Positioning
 System (GPS) 71
 Guidance Volume 11, 58

H

Handling the DVD Map Disc 65
 Head-Up Display (HUD) 63
 Home 43, 51
 Home and Away Preset
 Stations 19

I

Installing the DVD Map Disc 64
 Intersection 40
 Introduction 3

K

Keyless Access System 32

L

Language 6

M

Map 37

Map Adjustments 65

Map Appearance 68

Map Scales 65

Maps 63

Memory Points 38, 45

N

Navigation 54

Menu 70

Route Options 58

Set Up 54

Stored Locations 45

Symbols 66

Using the System 30

Navigation Buttons 30

O

Ordering

Map DVDs 73

Overview, Infotainment System ... 4

P

Phone Number 41

Playing a CD 21

Playing a CD Changer 22

Playing from an iPod® 27

Playing the Radio 12

Point of Interest (POI) 35

Preset Destination 42, 52

Preset Station Menu 15

Previous Destination 39, 52

Problems with Route

Guidance 72

Q

Quick POI Selection 54

R

Radio Data System (RDS)	17
Radios	
AM-FM Radio	12
Satellite	20
Region	32
Restore System Defaults	58
Route Options	58
Route Preferences	59
Route Preview	61

S

Satellite Radio	20
Scrolling the Map	66
Search Condition	59
Setting the Clock	7
Setting the Region, Entering an Address and Point of Interest, and Storing a Home Destination and Preset Destinations	7
Setting the Search Area	65
Sound Menu	16
Stored Locations	45, 11
Storing Radio Station Presets	6
Symbols, Navigation	66
System Needs Service, If	73

T

Touch-Sensitive Buttons	32
Traveling Across Regions	70
Two-Dimensional/ Three-Dimensional (2D/ 3D) View	54

U

User Settings	57
Using an MP3	24
Using Your Home or Preset Destinations	10

V

Vehicle
 Positioning71
Voice Recognition 74
Voice Recognition Commands ... 74

X

XM™ Satellite Radio Service 20